



BULLY DOG

#1 IN PERFORMANCE

gauge **GT** tuner



OWNERS MANUAL

Part 1: *Physical Installation*

Part 2: *Operations and Downloading*

Part 3: *Internet Updates*

Appendix: *OEM pyrometers, pyrometer calibration, and other topics.*

REMEMBER TO UPDATE!!!

Always update the GT before installing on a vehicle using the Update Agent internet update software. Visit www.bullydog.com to download the Update Agent and get installation instructions for the Update Agent. The diagram below shows just how easy it is to update any of our electronic products. For detailed update instructions check the operating instructions.

3.

Use the Update Agent to update the GT software before installation on vehicle. This will ensure that the GT has the latest programming available from Bully Dog.



2.

Plug the USB cable into a PC that has the Bully Dog Internet Update software: The Update Agent.

1.

Plug in the GT to the USB Cable. SD card must be installed in the GT.

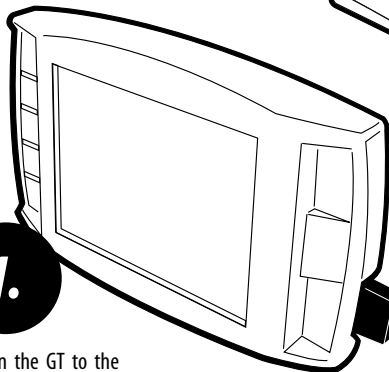

INTRODUCTION

Congratulations on the purchasing of the GT. The GT is one of the most technologically advanced tuning and monitoring devices available in the market place, second only to our Performance Management Tool (GT). The GT includes our Patent pending feature called the Driving coach which assist users in maximizing driving efficiency. Using the driving coach feature end users can see improvements in fuel economy that will save enough money on their monthly bill to completely offset the cost of the GT itself.

This product is a relatively easy product to install, if installation assistance is required this product can be installed by any Bully Dog dealer and can also be installed using the assistance of our technical support team.

At any time during installation and for operating or updating questions please call our technical support line: (866)-285-5936.

For other information visit our web site: www.bullydog.com

This instruction set outlines how to install and operate the GT gauge Tuner.



DIESEL *applications*



DODGE

RAM

5.9L Cummins '03-'07 2500

5.9L Cummins '03-'07 3500

6.7L Cummins '07-'09 2500

6.7L Cummins '07-'09 3500

6.7L Cummins '07-'09 4500

6.7L Cummins '07-'09 5500



CHEVROLET/GMC

EXPRESS	6.6L Duramax '06-'09 2500
	6.6L Duramax '06-'09 3500
SAVANNAH	6.6L Duramax '06-'09 2500
	6.6L Duramax '06-'09 3500
SILVERADO	6.6L Duramax '01-'09 2500
	6.6L Duramax '01-'09 3500
SIERRA	6.6L Duramax '01-'09 2500
	6.6L Duramax '01-'09 3500
KODIAK	6.6L Duramax '06-'09 4500
	6.6L Duramax '06-'09 5500
TOPKICK	6.6L Duramax '06-'09 4500
	6.6L Duramax '06-'09 5500

FORD

E-250	6.0L Power Stroke '03-'07
E-350	6.0L Power Stroke '03-'09
E-450	6.0L Power Stroke '03-'09
EXCURSION	6.0L Power Stroke '03-'06
	7.3L Power Stroke '99-'03
F-250	6.0L Power Stroke '03-'07
	6.4L Power Stroke '08-'09
	7.3L Power Stroke '99-'03
F-350	6.0L Power Stroke '03-'07
	6.4L Power Stroke '08-'09
	7.3L Power Stroke '99-'03
F-450	6.0L Power Stroke '03-'07
	6.4L Power Stroke '08-'09
	7.3L Power Stroke '99-'03
F-550	6.0L Power Stroke '03-'07
	6.4L Power Stroke '08-'09
	7.3L Power Stroke '99-'03

GAS applications

CHEVROLET/GMC/CADILLAC

AVALANCHE

5.3L V8 '02-'09

6.0L V8 '07-'08

8.1L V8 '02-'06

ESCALADE

5.3L V8 '02-'05

6.0L V8 '02-'06

6.2L V8 '07-'09

EXPRESS /SAVANNAH

5.3L V8 '03-'09 1500

6.0L V8 '03-'04 1500

4.8L V8 '03-'09 2500

5.3L V8 '03-'05 2500

6.0L V8 '03-'08 2500

4.8L V8 '04-'09 3500

6.0L V8 '03-'08 3500

8.1L V8 '01-'03 3500

SIERRA/SILVERADO

4.8L V8 '99-'09 1500

5.3L V8 '99-'09 1500

5.3L V8 '99-'00 2500

6.0L V8 '01-'07 Classic

6.0L V8 '02-'07 Denali

6.0L V8 '07-'08 Vortec

6.0L V8 '99-'08 2500

6.2L V8 '07-'09 Denali

8.1L V8 '01 1500

8.1L V8 '01-'07 2500

TAHOE

4.8L V8 '00-'09

5.3L V8 '00-'09

YUKON/SUBURBAN

4.8L V8 '00-'09

5.3L V8 '00-'09

5.3L V8 '00-'09 XL

6.0L V8 '00-'08 Suburban

6.0L V8 '01-'06 Denali

6.0L V8 '01-'06 Denali XL

6.0L V8 '01-'06 XL

6.2L V8 '07-'09 Denali

6.2L V8 '07-'09 Denali XL

6.2L V8 '01-'06 XL

8.1L V8 '01-'06 Suburban

DODGE

RAM

5.7L V8 Hemi'03-'08 1500
 5.7L V8 Hemi'03-'08 2500
 5.7L V8 Hemi'03-'08 3500

FORD/LINCOLN

EXCURSION

5.4L V8'04-'05
 6.8L V10'04-'05

EXPEDITION

4.6L V8'04-'05
 5.4L V8'05-'07

EXPLORER

4.6L V8'07
 5.4L V8'05-'07

F-150 / E-150

4.6L V8'04-'08
 5.4L V8'04-'08

F-250 / E-250

4.6L V8'04-'05
 5.4L V8'04-'08
 6.8L V10'04-'08

F-350 / E-350

5.4L V8'04-'08
 6.8L V10'04-'08

F-450 / E-450

6.8L V10'04-'08

F-550 / E-550

6.8L V10'04-'08

MOTORHOME

5.4L V8'04
 6.8L V10'04-'08

MARK LT

5.4L V8'05-'07

MUSTANG

4.0L V6'07-'08
 4.6L V8'05-'08

NISSAN/INFINITY

TITAN

5.6L V8'05-'09

ARMADA

5.6L V8'05-'09

PATHFINDER

5.6L V8'08-'09
 4.0L V6'05-'09

FRONTIER

4.0L V6'05-'09

PATHFINDER

4.0L V6'05-'09

QX56

5.6L V8'05-'09

PART 1

Physical Installation

These operating instructions are split into four sections:

SECTION 1: Parts Included

SECTION 2: Parts Description

SECTION 3: Installation Overview

SECTION 4: Installation

SECTION 5: Mounting the GT using the Windshield mount

PART 1 PHYSICAL INSTALLATION CONTENTS

ONLINE UPDATES	PG.2
INTRODUCTION	PG. 3
GT DIESEL APPLICATIONS	PGS. 4-5
GT GAS APPLICATIONS	PGS. 6-7
TABLE OF CONTENTS	PG. 9
BILL OF MATERIALS	PG. 10
PARTS DESCRIPTION	PGS. 11-14
GT Head Unit.....	pg. 11
OBD II Adapter Plug.....	pg. 512
GT Main Wire Harness.....	pg.13
Power Wire	pg. 13
Micro SD Card.....	pg. 14
Universal Windshield Mount.....	pg. 14
INSTALLATION	PGS. 15-20
Installation Overview	pg. 15
Installation	pg. 16
Step 1: Connecting the OBDII	pg. 16
Step 2: Connecting the Power Wire	pg. 17
Step 3: Running GT Main Wire Harness	pg. 19
Mounting GT to Windshield Mount	pg. 20

SECTION 1: Parts Included

The list below includes by name the major parts included in your GT package. The tools list indicates all of the tools necessary to complete the GT install.

TOOLS NEEDED

- Fuse Puller
- Voltage Meter (optional)

EXTRA PARTS (optional)

- Fuse Jack
- Spade connector

1. The GT/Watch Dog Head Unit

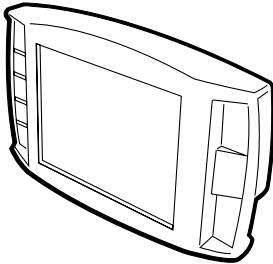

2. OBDII Adapter Plug

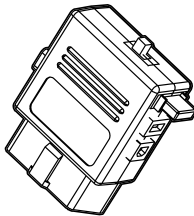

3. Main Wire Harness

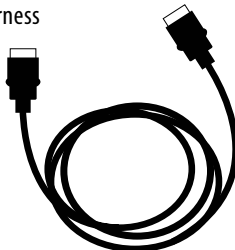

4. The GT/Watch Power Wire

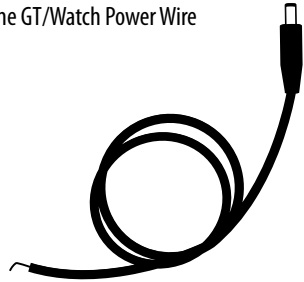

5. Micro SD Card



3. Windshield Mount

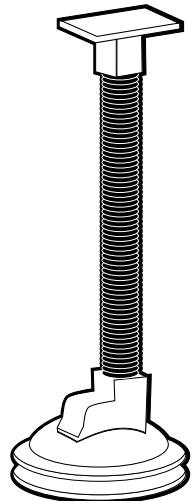

SECTION 2: Parts Description

This section describes each of the parts in the Parts List, each description provides a physical set of attributes and a purpose for each part. The parts descriptions also list everything that is included in each assembly.

THE GAUGE TUNER:

The main component is the GT Head Unit. The Head Unit is the interface through which all operating functions take place including: Downloading, Monitoring, and the Driving Coach feature.

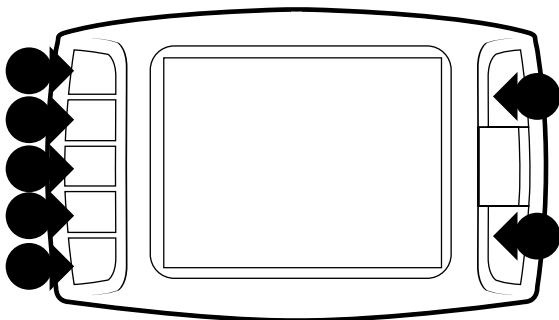

GT Front Side:

The GT has seven capacitive touch buttons. Capacitive touch buttons are a button style that is sensitive to the presence of your finger. Capacitive buttons do not need to be pushed, only touched to activate. The GT interface features a 2.4" LCD screen.

GT Parts Back side:

1. T-slot Mount Socket, this will work with a large range of off the shelf mounting options.
2. Main harness port, electronic port for the main harness.
3. Micro SD Card Slot
4. Mini USB port

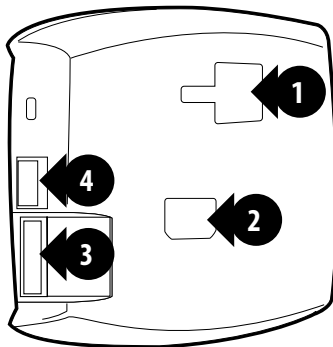

OBDII ADAPTER PLUG

The OBDII Adapter is a communication hub for the GT. The OBD II Adaptor plugs directly into the vehicle OBD II port. Notice the OBD II Adaptor has many ports to support various other functions of the GT. The diagram below illustrates all of the OBDII parts and ports.

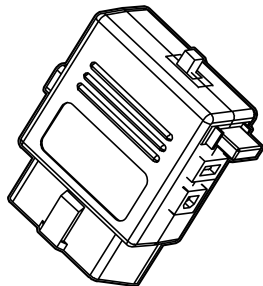

1. **OBD II Male End:** this is the part of the adapter plug that plugs into the vehicle OBDII port.
2. **Main Harness port:** the main harness will plug into the GT and into this port during installation.
3. **Power wire port:** the power wire will run from this port to the vehicle fuse box during installation. Plug into the GT and into this port during installation.
4. **Power Supply Switch:** use this switch to change power from running off of the Power Wire to OBD II power as a power supply for the GT.
5. **Four Pin USB:** This port is used if a Bully Dog pyrometer kit is purchased for the GT.
6. **Five Pin USB**
7. **Adapter Plug Fuse**

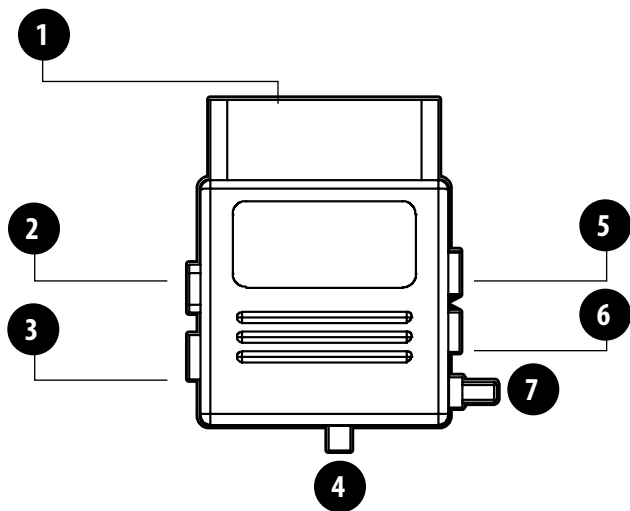

GT MAIN WIRE HARNESS

The main harness connects the GT to the OBD II Adapter Plug and acts as the main line of communication for the GT.

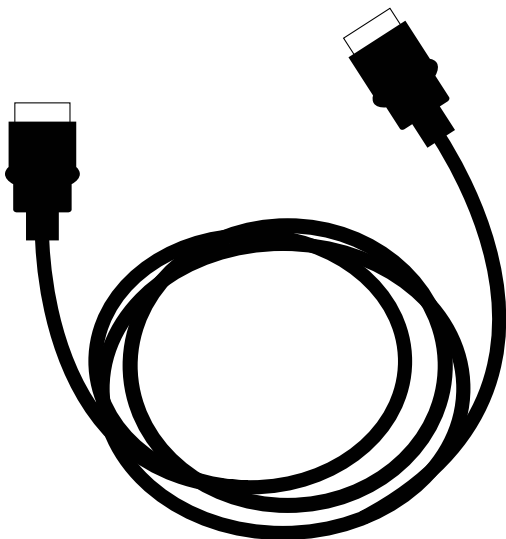

POWER WIRE

The Power wire connects the OBD II Adaptor Plug to the vehicle fuse box to supply power to the GT.

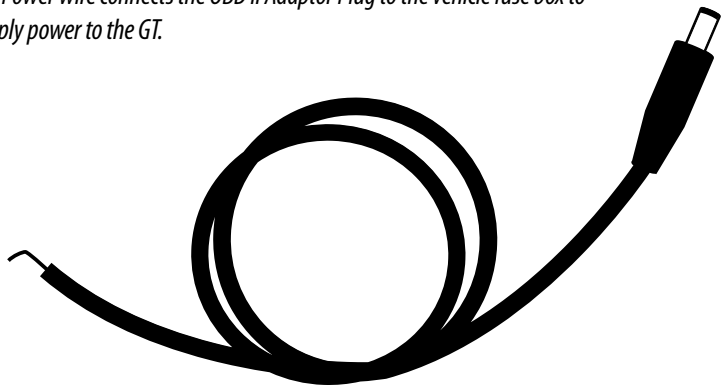

MICRO SD CARD

The Micro SD Card holds all of the electronic files necessary to properly start up the GT, the SD card must be installed into the micro SD card slot on the side of the GT at all times.

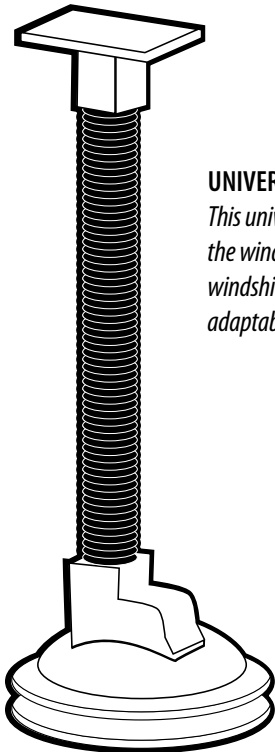
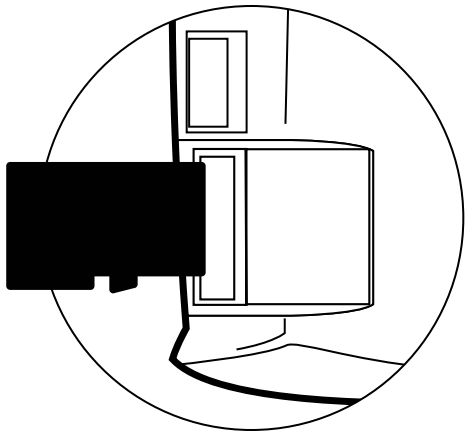

UNIVERSAL WINDSHIELD MOUNT

This universal windshield mount is used to install the GT firmly onto the windshield, it is a suction cup mount that will work on any vehicle windshield. Check our web site for other mounting options, the GT is adaptable to a range of other mounting styles.

SECTION 3: Installation Overview

The installation overview illustrates a properly installed GT. This overview is meant to help reference the general location of installed parts and pieces of the GT. Note that some fuse boxes will be located inside the cab of the vehicle and will not require that the power wire go through the vehicle fire wall.

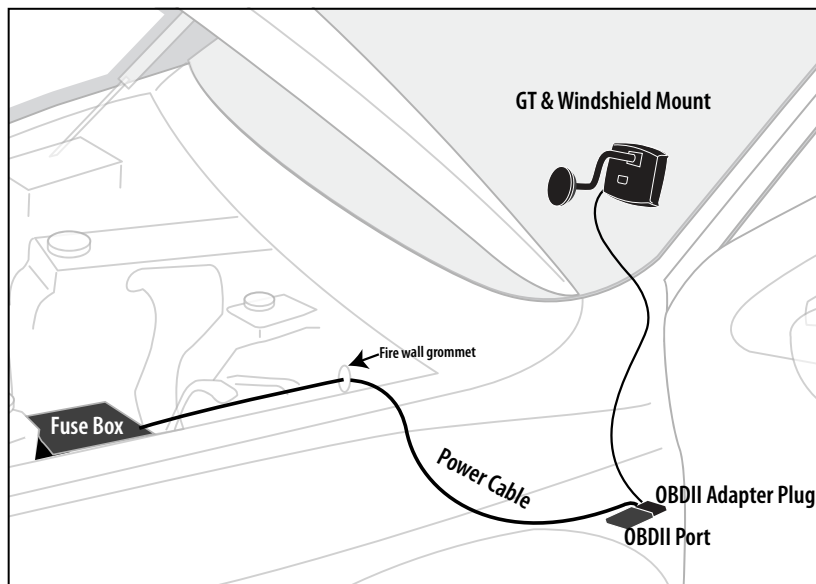

SECTION 4: Installation

These installation instructions are split into five Easy Steps. Follow the steps for the easiest installation of this product.

STEP 1: CONNECT THE OBD II ADAPTER TO THE VEHICLE OBD II PORT

This step involves locating the vehicle's OBD II port and then simply plugging the OBD II Adapter Plug into the OBD II port.

1. As the illustration below shows, OBD II ports are always located somewhere under the drivers side dash. The OBD II port is a male receiver that will have the same shape as the end of the OBD II Adaptor plug.
2. Once the OBD II port is located, then simply plug the OBD II Adaptor plug into the OBD II port.

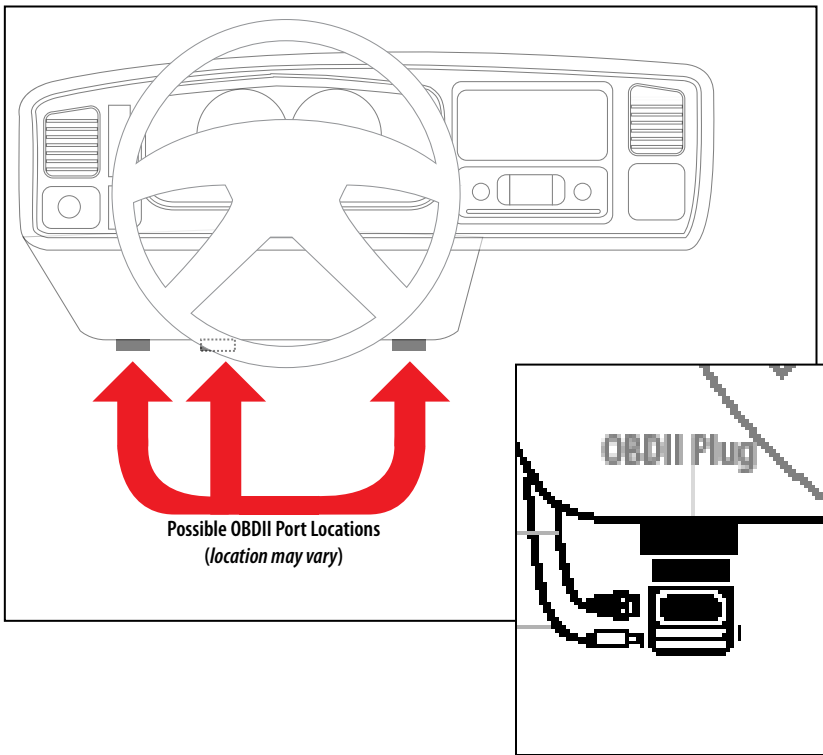

STEP 2: CONNECT THE POWER WIRE TO THE VEHICLE FUSE BOX

Step two involves locating the correct fuse within the vehicle fuse box, and connecting the power wire from the OBD II Adaptor plug to the fuse in the fuse box.

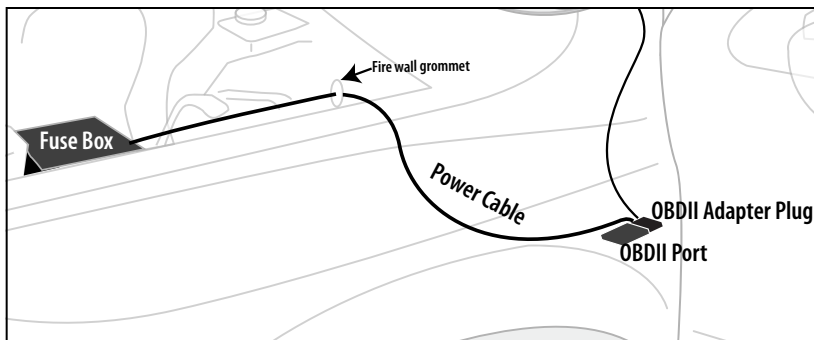

IDENTIFY THE CORRECT FUSE:

1. Locate the vehicle fuse box; the vehicle owners manual will indicate where the fuse box is located within the vehicle.
2. Open the fuse box and identify a fuse that has "key on power." To identify the correct fuse, find an accessory fuse using the fuse diagram in the vehicle owners manual. If the vehicle manual does not help identify an accessory fuse use a voltage meter to identify a fuse that supplies power only when the key is in the on position.

CONNECT THE POWER WIRE FROM THE OBD II BLOCK TO THE CORRECT VEHICLE FUSE:

1. Connect the power wire to the power wire port on the OBD II Adaptor plug.
2. Run the raw end of the power wire to the vehicle fuse box, in many cases this will mean taking the power wire through the vehicle fire wall. On most vehicles the power wire can run through an existing port, it is not necessary to drill.
3. Remove the correct fuse from the fuse box and plug the fuse back into its original location along with the power wire. For a the cleanest install see our clean install instructions on the next page.

FOR A CLEAN INSTALL INTO THE FUSE LOCATIONS:

There are multiple different fuse types in OEM vehicles. For a clean install, use a fuse tap and spade connector that will work with the specific fuse being used for this install.

1. Once the end of the power wire is near the fuse box, prepare the end of the power wire by attaching a spade connector to the end of the wire.
2. Remove the correct fuse from its location and then replace that fuse with a fuse tap that is made for that size of fuse.
3. Connect the spade connect to the end of the fuse tap.
4. Use zip ties to secure any loose wire left hanging from excess slack in the power wire.

STEP 3: RUN GT MAIN WIRE HARNESS

In this section you will connect the GT Main Harness to the OBD II Adaptor plug and then run the other end of the main harness up the side of the vehicle dash and connect it to the back of the GT.

1. Plug one end of the Main Harness into the Main Harness port on the OBD II adaptor plug.
2. Run the other end of the harness up through the vehicle dash on the driver's side so that the end of the harness emerges from the dash near the vehicle A-pillar. It may be necessary to temporarily remove the vehicle weather stripping and dash panel to achieve an installation where the Main Harness cannot be seen.
3. Plug the Main Harness into the back side of the GT, make sure that there is enough slack in the main harness to accommodate mounting the GT to the windshield.

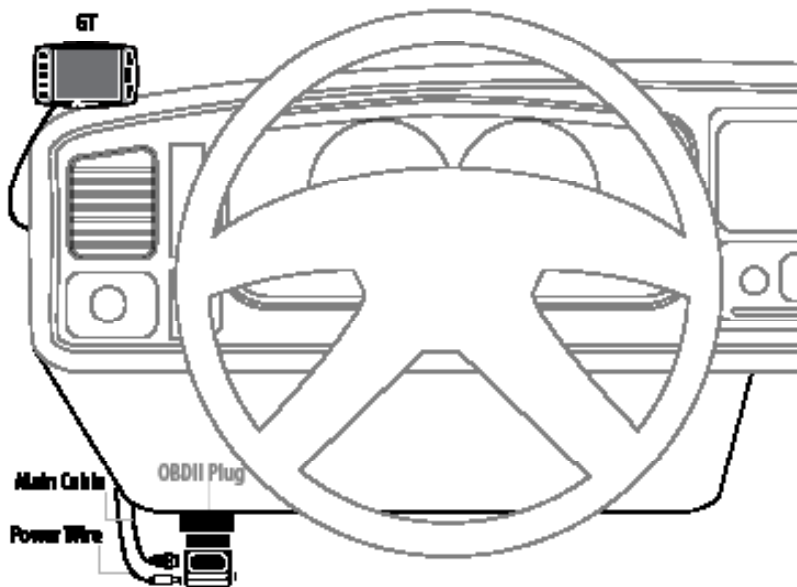

SECTION 5: Mounting the GT using the Windshield mount

The final step to installation is mounting the GT to the windshield using the universal windshield mount.

1. Locate the T-shaped mount socket on the back side of the GT.
2. Notice that the top of the universal mount will fit into T-shaped socket and slide forward to secure the GT to the mount.
3. With the GT connected to the mount use the windshield mount to secure the GT to the windshield. Be sure that the position of the GT does not obstruct the view of the road or distract the driver from their primary responsibility, which is driving responsibly.

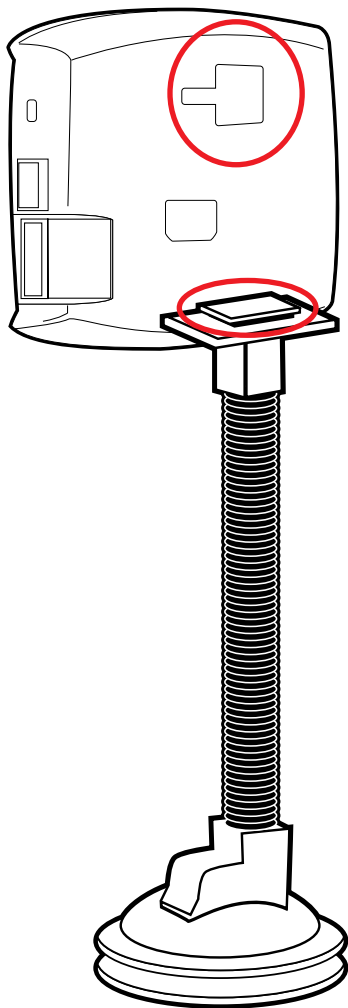

PART 2

Operating Instructions

These operating instructions are split into four sections:

SECTION 1: Button Navigation

SECTION 2: Set up Wizard for installing download

SECTION 3: Exploring the General Display

SECTION 4: The Driving Coach

SECTION 5: Main Menu and Sub Menus

OPERATING INSTRUCTIONSPGS. 28-44

SECTION 1: Button Navigation pg. 23

SECTION 2: GT Setup Wizard for Installing Download pgs. 24-26

Step 1: The Setup Wizard	24
Step 2: Vehicle Selection	25
Step 3: The Download	34

SECTION 3: Exploring the Menu System..... pgs. 27-29

Five Button Functions of the Main Screen	pg. 28
Large Gauge Styles/The Driving Coach	pg. 29

SECTION 4: The Driving Coach pgs. 30-31

Driving Coach Setup Wizard.....	pg. 30
Driving Coach Display	pg. 31

SECTION 5: Main Menu & Sub-menus pgs. 32-52

Change Vehicle.....	pg. 33
Install download	pg. 34
Gauge Setup.....	pg. 47
Driving Coach Setup Wizard.....	pg. 49
User options	pg. 53
Vehicle Options	pg. 57

SECTION 1: Button Navigation

Capacitive Touch Buttons: The buttons used on the GT are Capacitive touch. Capacitive touch buttons only require a touch on the button area rather than a push like regular buttons require. It is not necessary to apply any significant force to the button while navigating through product screens.

Press the top left button to enter the Main Menu, also use this button to exit menus.

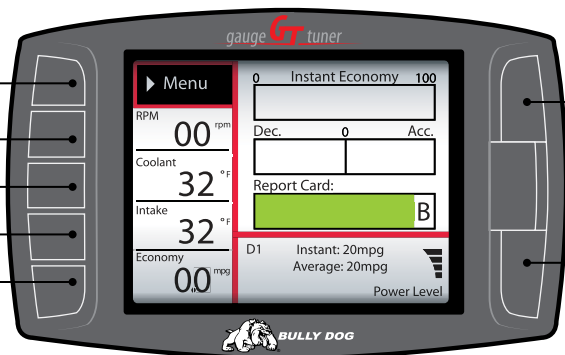

Press any of the four buttons on the left to select items on the screen that are adjacent to the button position.

In general these buttons work as up and down buttons, they may also be used to select items on the screen adjacent to these buttons.

SECTION 2: Set up Wizard for installing download

The Setup Wizard is a step by step process through the vehicle selection process and download process. The Setup Wizard appears on the screen automatically and will only appear the very first time the GT is installed. Opting out of the Setup Wizard is OK, the vehicle selection process and download process can also be performed through the main menu.

STEP 1: THE SETUP WIZARD:

1. Once physical installation is complete insert the key into the vehicle ignition and turn it to the on/run position.
2. The GT screen will now light up and the Setup Wizard will appear on the screen.

Turn key to the "ON" position when the Tuner calls for it.

Do not start the engine unless the instructions or the tuner specifically calls for it.

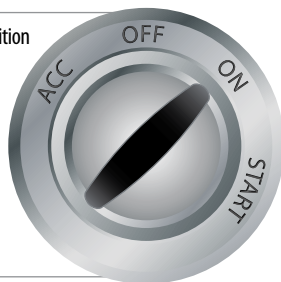

TROUBLE SHOOTING: If the Setup Wizard does not appear automatically and the GT displays the Main Screen then the vehicle selection process and download process will have to be performed through the main menu. From the main screen enter the main menu and navigate to the Change Vehicle screen. Once the correct vehicle is selected, enter the download menu from the main menu.

STEP 2: VEHICLE SELECTION

Select the option from the vehicle selection screen that most matches the vehicle in use; the GT will not be able to perform a download or monitor correctly if the correct vehicle type is not specified.



The list of vehicles in the illustration below demonstrate the vehicle selection list for the Diesel version of the GT; the Gasoline version will have a completely different list.

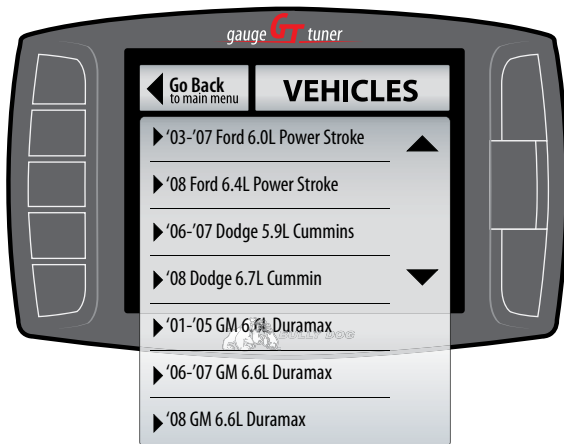

STEP 3 THE DOWNLOAD:

In Step 2, select whether to install a performance download now or later. The setup wizard will initiate the download. For details on the download process see the Install download section on page 34. It is OK to opt out of the Download at this point in the setup wizard. It is very easy to load and unload the download from the main menu.



Opt in: To complete the download in the setup wizard process simply press the up arrow button to select "Yes." Then simply follow the on screen instructions to complete a download.



Opt out: If you choose to not download at this time you will still have monitoring capabilities even though no download has been entered into the vehicle. To download at a later time see the Install Download instructions when ready.

SECTION 3: Exploring the main screen

The Main Screen is the screen that displays vehicle activity, it is also the screen from which the main menu is accessed. The main screen has a multitude of different functions; the diagrams in this section fully explain each function accessed from the main menu. The first diagram displayed names all the parts of the main screen.

See the list of main screen functions on the following page.

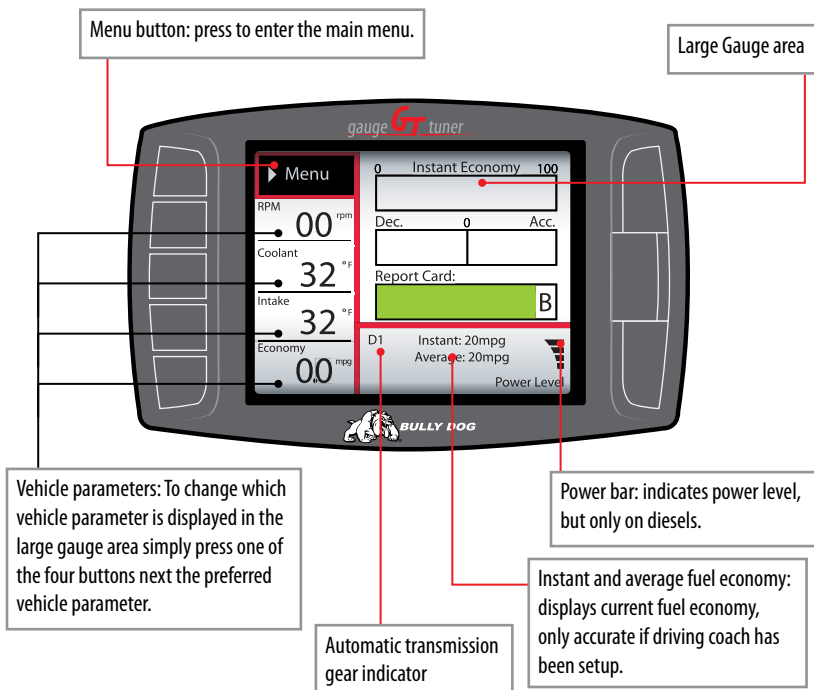

FIVE BUTTON FUNCTIONS OF THE MAIN SCREEN:

FUNCTION 1: Press the top left button to enter the Main Menu, also use this button to exit menus.

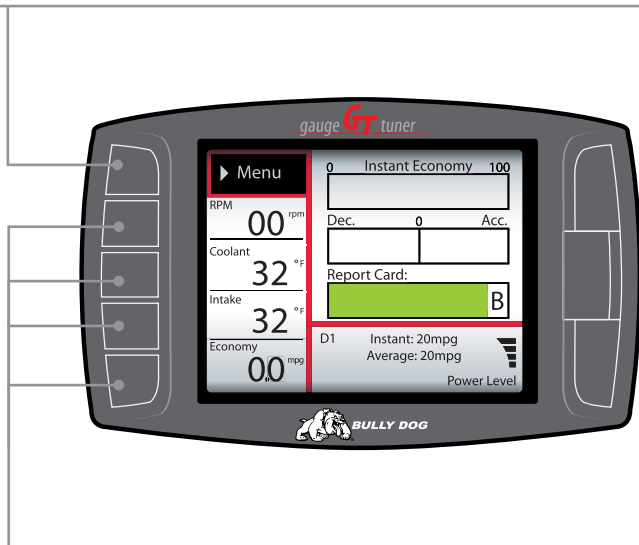

FUNCTION 2: Press any of the four buttons on the left side of the GT adjacent to one of the vehicle parameters on the screen will display that parameter in the large gauge area.

FUNCTION 3: Continuously hold any of the four buttons to change the Large Gauge style, there are four different styles that pop up. The first style is the Driving Coach. See the next page to see each gauge style, and the Driving Coach.

FUNCTION 4: Diesel Only

Power Level Up

Power Level Down

Use the power level buttons to control power levels on-the-fly only while in the main screen.

FUNCTION 5: For diesel and gasoline vehicles, continuously holding the upper right button will change the GT color theme. The screen theme will continue to change as the button is held.

LARGE GAUGE STYLES/THE DRIVING COACH

The large gauge can display in three different gauge styles plus the Driving Coach.

Hold the button down next to the vehicle parameter currently displayed in the large gauge area to switch between the different large gauge display types.

The diagram shows a central gauge tuner interface with a 'Menu' button and various vehicle parameters. Four callout boxes illustrate different display styles for the large gauge area:

- 1. The Driving Coach**: A digital display showing 'Instant Economy' (0-100), 'Dec.' (0), 'Acc.' (0), and a 'Report Card' with a green bar and the letter 'B'.
- 2. Analog gauge with average and max peaks**: A semi-circular analog gauge for MPH (0-120) with a needle pointing to approximately 40. It includes 'AVG PEAK: 0 MPH' and 'MAX PEAK: 0 MPH'.
- 3. Analog gauge with mini graph**: A semi-circular analog gauge for MPH (0-120) with a needle pointing to approximately 40. It includes a 'PEAK: 0 MPH' label and a small grid graph below the gauge.
- 4. Large real time graph**: A large grid graph showing a real-time data trace. The vertical axis is labeled from 20 to 140 in increments of 20.

SECTION 4: The Driving Coach

The Driving Coach is a special feature designed to help drivers drive more efficiently. It coaches drivers into better driving habits by providing real time visual and audio feedback as to how efficient a driver is driving. The driving coach also provides the driver with a “grade,” on how efficiently they drove during a particular trip. This makes driving efficiently, fun, drivers can coach themselves to constantly improve driving habits. Every driver can challenge themselves to be: “The perfect driver.”

The underlying bonuses included with the Driving Coach: driving more efficiently saves the driver money and preserves the environment.

DRIVING COACH SETUP WIZARD:

Before the Driving Coach will accurately calculate fuel economy and wasted energy it must be setup using the Driving Coach Setup Wizard. Access the Driving Coach Setup Wizard in the main menu; for information on the Driving Coach Setup Wizard go to page 49.

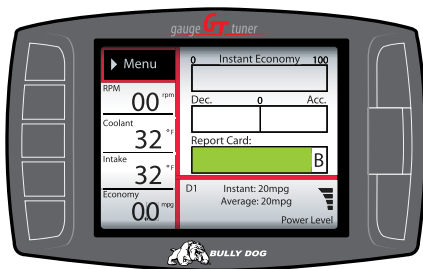

DISPLAY THE DRIVING COACH:

The Driving Coach is always running, whether the driver chooses to display the driving coach or not. Follow the steps below to display the Driving Coach, and to hide the Driving Coach.

How to display the Diving Coach:

Continuously hold any of the four buttons, adjacent to the vehicle parameters displayed on the screen, on the left side of the GT. As any of the four buttons are continuously held the Large Gauge area will rotate through four different gauge styles and the Driving Coach. Simply release the button when the Driving Coach appears in the Large Gauge area.

How to hide the Driving Coach:

Simply hold any of the four parameter buttons while viewing the main screen and the Large Gauge area will change into one of the four different gauge styles.

THE DRIVING COACH DISPLAY DIAGRAM

The large gauge area is where the Driving Coach information is displayed. The diagram below illustrates the information that is collected and displayed by the Driving Coach.

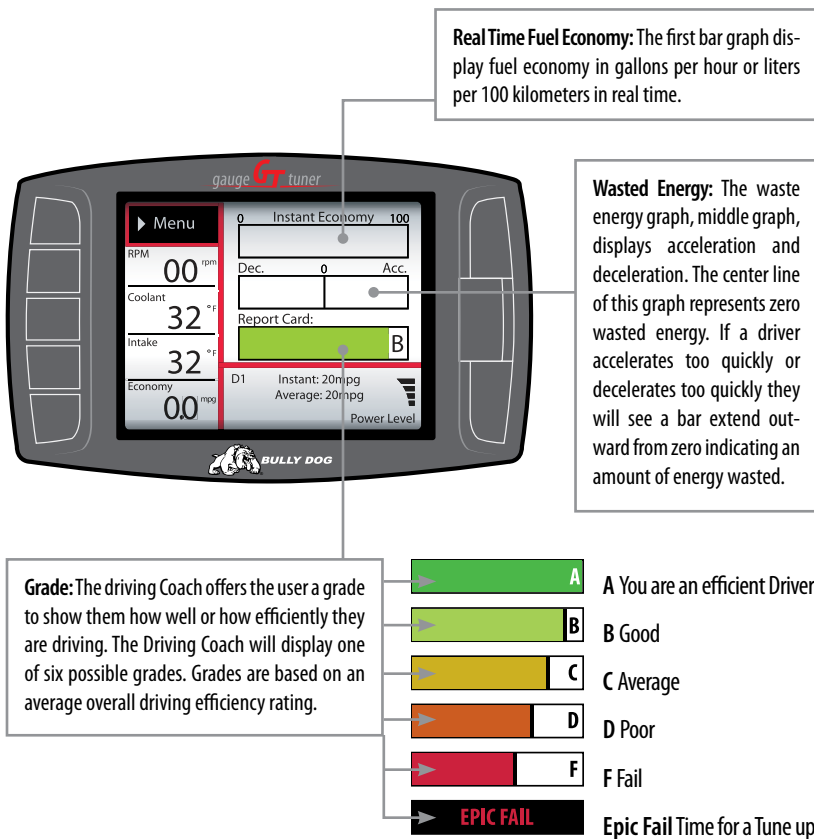

SECTION 5: Exploring the Main Menu and submenu systems

The diagram below shows all of the Main Menu items, some menu items are vehicle specific as noted adjacent to those menu items. Section 5 includes comprehensive information on each main menu item and all sub menus.

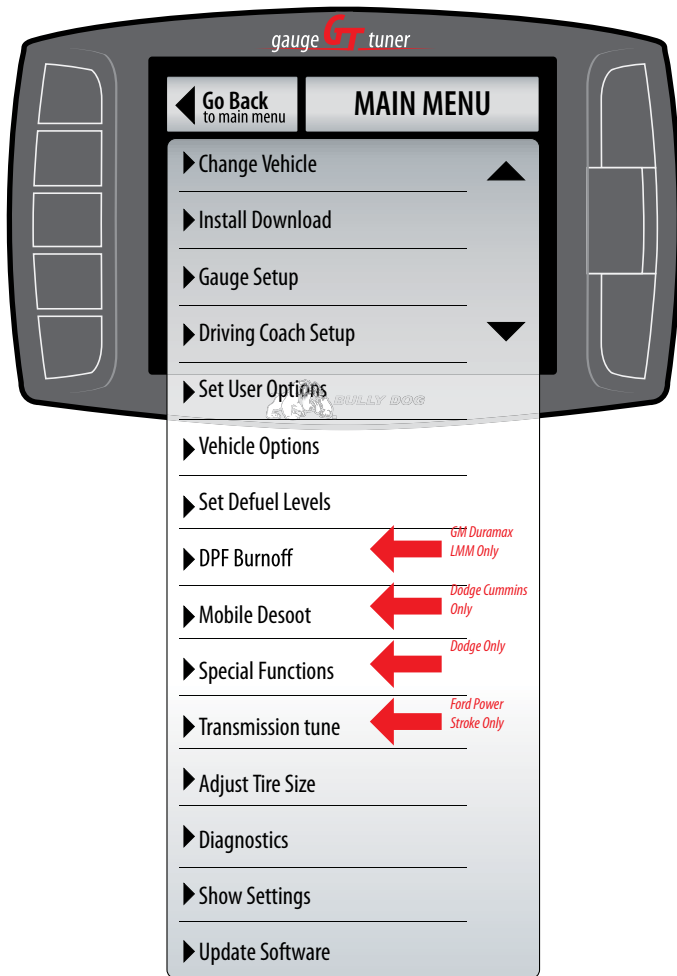

CHANGE VEHICLE:

The Change Vehicles Menu is only used for two reasons:

1. The GT is being transferred to a new vehicle. Note the GT Installed Download feature must be returned to stock before it is transferred another vehicle.
2. If the wrong vehicle is selected the correct vehicle can be selected in the Change Vehicle menu.

Note: the Micro SD Card must be in the GT to change vehicles.

If the Change Vehicle menu does not list a vehicle type, check the vehicle applications charts at the beginning of this owners manual or call tech support for clarification.

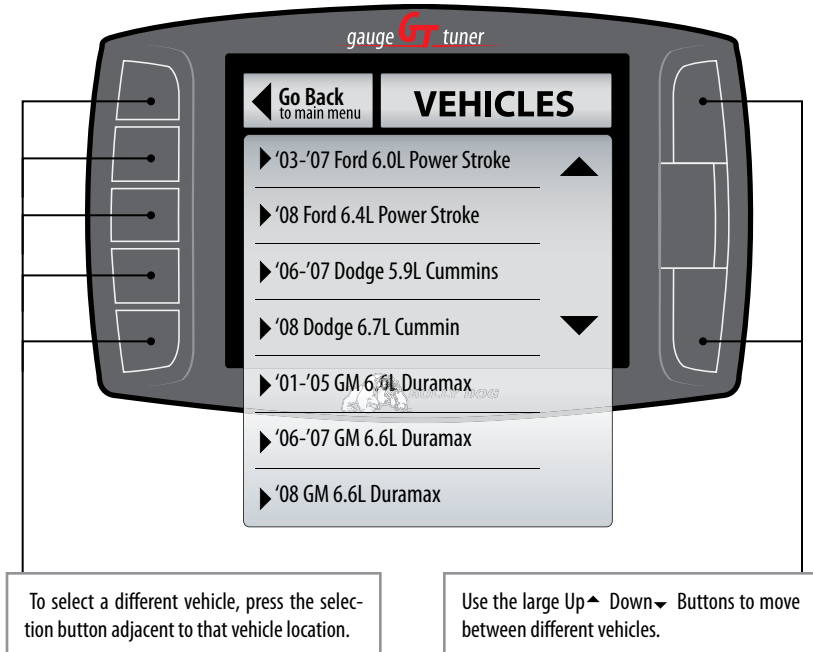

To select a different vehicle, press the selection button adjacent to that vehicle location.

Use the large Up Down Buttons to move between different vehicles.

INSTALL DOWNLOAD

The install download feature is the feature that reprograms the vehicle for improved Horsepower and Torque and improved fuel economy. The available tuning is different on diesel vs. gasoline applications. The charts below show the estimated horsepower gains for both gas and diesel. Be sure to read the cautionary information for gasoline engines, and read the Download Installation precautions on the following page.

The install download option should be used for three different purposes:

1. Install a download onto a stock vehicle:
2. Changing the current download settings: If the vehicle already has a download loaded, download settings can be changed by performing another download.
3. Return a vehicle to stock: To completely return a vehicle to its factory stock conditions.

THE SD CARD MUST BE INSERTED IN THE SIDE OF THE GT TO DOWNLOAD TO A VEHICLE.

Diesel Tuning: The diesel tuning is the only tuning available that is adjustable on the fly, this means that the level of added horsepower can be adjusted from the Main Screen once a download has been completed on the vehicle..

SETTING	PEAK HORSEPOWER	PEAK TORQUE
Extreme	up to 119	up to 250
Performance	75+	125+
Tow/ Economy	50+	100+
Stock Power	stock	stock

Gasoline Tuning: There are two gas tunes available, pay attention to the fuel requirements. Failure to comply with fuel octane requirements can result in engine damage.

SETTING	PEAK HP	PEAK TQ	OCTANE
High Octane	up to 35	up to 40	91+ octane
Regular	15-20	15-20	85+ octane
Stock	Stock	Stock	OEM Spec.

DOWNLOADING INSTALLATION PRECAUTIONS: (VERY IMPORTANT)

It is important to take some precautions before downloading, re-downloading, or returning to stock. These precautionary steps to installing the Download will help ensure that downloads are successful.

1. Before installation, always update the GT Product online using the Update Agent. The Update Agent is an online program that loads the latest vehicle programs from our web site to the GT.
2. It is recommended that you install during business hours, in case a tech is needed. Regular business hours are: Monday-Friday 8am-5pm Mountain Standard Time)
3. Do not install while the vehicle is in a remote location or when the vehicle is immediately needed for transportation. In the unlikely event that installation of the download fails, the installer may need resources such as computer access and internet access to complete installation.
4. Allow up to one hour for installation. The GT easily installs in under 30 minutes. However, allocate at least an hour for installation in case any problems are encountered during installation.
5. Before installation, always make sure that the batteries have a full charge. It is even a good idea to have a battery charger nearby in case the batteries start draining. If the batteries lose their charge during a download, the download will fail.
6. Before installation, turn off all electronics inside the vehicle including: headlights, heater, air conditioning, stereo, any DVD players, etc. Failing to turn off all electronics may prevent a successful download.
7. During installation it is very important that the GT is not disrupted. If the download is disrupted the vehicle may not start and the download process must be restarted. In worst case scenarios the Power Pup™ will have to perform a recovery process which adds even more time to the installation process.

The information above is extremely important to successful use of the Download

IMPORTANT

It is not recommended that this product be used in conjunction with any other electronic module or tuner that is intended to increase horsepower.

Performance products must always be removed before taking the vehicle in for any kind of service. The Bully Dog software will be lost if an OEM scan tool is used to reflash the engine computer.

REMOVING FUSES FOR '01-'02 GM DURAMAX VEHICLES

IMPORTANT: Skip the steps on this page if your vehicle is not an '01-'02 GM 6.6L Duramax.

WARNING: Failure to remove the fuses while downloading the programs into the computer may result in computer hardware failure. After download is complete replace all fuses

Note: Use your fuse puller included with your vehicle or a pair of needle nose pliers to pull the fuses.

•'01-'02 Duramax: Refer to Figure 1 to see the fuses that must be removed prior to tuner installation.

- SEO ING
- RD01
- RAP2

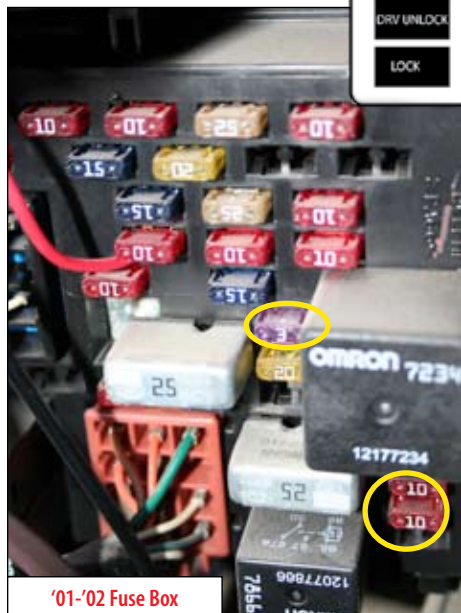
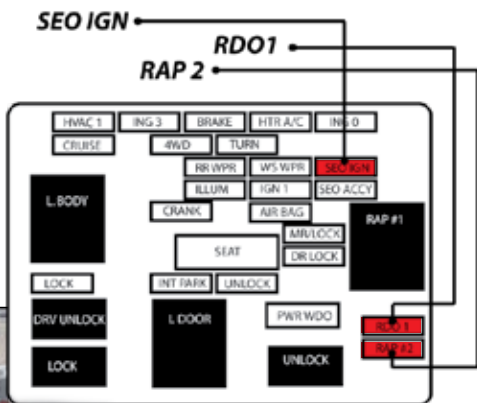

IMPORTANT: This fuse box is located inside the cab on the driver's side

REMOVING FUSES FOR '03-'05 GM DURAMAX VEHICLES

IMPORTANT: Skip the steps on this page if your vehicle is not an '03-'05 GM 6.6L Duramax.

WARNING: Failure to remove the fuses while downloading the programs into the computer may result in computer hardware failure. After download is complete replace all fuses.

•'03-'05 Duramax: Refer to Figure 2 to see the fuses that must be removed prior to tuner installation.

- TBC BATT
- TBC IGN1
- Radio
- INFO

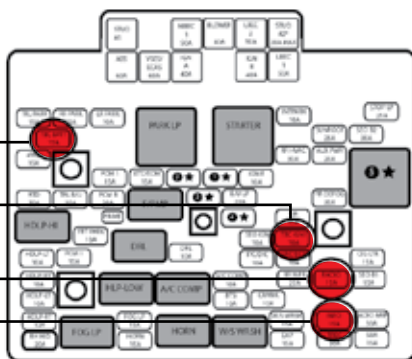

Note: Use your fuse puller included with your vehicle or a pair of needle nose pliers to pull the fuses.

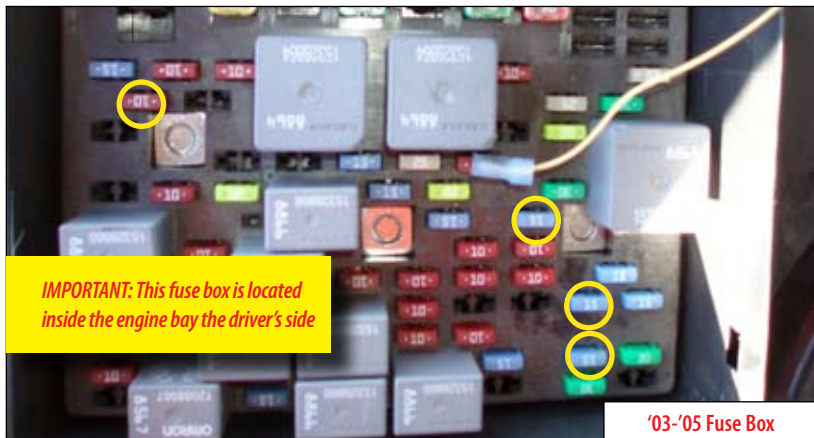

IMPORTANT: This fuse box is located inside the engine bay by the driver's side

'03-'05 Fuse Box

FUSE INFORMATION GM '99-'06 ONLY

Before installing a download into the vehicle always pull the fuses mentioned below for the GM applications mentioned below. Be sure to replace all of the fuses back into the vehicle fuse box once a download has been completed.

'99-'02 GM C/K w/4.8/5.3/6.0/8.1L Engines

Remove these Fuses from the Fuse Box Located Inside the Vehicle (*located near the driver's side dash*)

- #1 - SEO ING (Special Eq. Options/Ignition)
- #16 - SEO ACCY (Special Eq. Options/Accessories)
- #29 - RDO1 (Radio)
- #30 - RAP2 (Relay Power)

Remove these Fuses from the Fuse Box Located Under the Hood

- #60 - TBC (Body Computer)

'03-'06 GM C/K w/4.8/5.3/6.0/8.1L Engines

Remove these Fuses from the Fuse Box Located Inside the Vehicle (*located near the driver's side dash*)

- #16 - SEO ACCY (Special Eq. Options/Accessories)
- #17 - TBC 2B (Body Computer)
- #18 - TBC 2C (Body Computer)
- #20 - TBC ACCY (Body Computer)
- #23 - TBC 2A (Body Computer)

Remove these Fuses from the Fuse Box Located Under the Hood

- #16 - TBC BATT (Body Computer)
- #38 - TBC IGN1 (Body Computer)
- #50 - Radio
- #58 - INFO

Replace all fuses after the download is complete!

PERFORMING A VEHICLE DOWNLOAD:

Performing a download is a very simple operation, simply follow the instructions displayed on the GT screen. Before downloading to a vehicle be sure to read all download installation precautions and remove all fuses on GM brand vehicles. Note fuses must be replaced after a download is complete. Throughout the download process the GT will prompt the user to enter engine tuning information and specify desired download feature information. It is important that the installer remain with the GT throughout the entire download process.

Turn key to the "ON" position when the GT calls for it.

Do not start the engine unless the instructions or the GT specifically call for it.

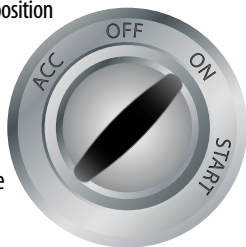

The information in this subsection will cover:

- *Engine Tuning*
- *Vehicle Specific Download features*
- *Changing Download Settings*
- *Returning to Stock*
- *Transferring to a new vehicle*

Engine Tuning:

During the download the GT will prompt all gasoline users to select the desired engine tune. At this point simply specify the engine tune; the table below illustrates the three settings available: Premium, Regular, and Stock. Diesel users do not have to select an engine tune, the diesel GT automatically loads the tuning information into the vehicle.

Gasoline engine tuning options

SETTING	PEAK HP	PEAK TQ	OCTANE
Premium	up to 35	up to 40	91+ octane
Regular	15-20	15-20	85+ octane
Stock	Stock	Stock	OEM Spec.

ATTENTION: Downloading the "Premium" setting requires that the vehicle run 91+ octane fuel. Failure to run at least 91 octane fuel with the "Premium" setting may result in engine damage.

Vehicle Specific Download Features:

The second step in the download process is selecting vehicle specific download features. This part of the process includes choosing to modify vehicle speed limiters, rev limiters, shift points and so on. Not all features will be available on each vehicle so this section highlights both features that are available for most or all vehicles and vehicle specific sections that contain features on available on the vehicle addressed.

The vehicle specific features will appear in sequence throughout the download process. Simply follow the on screen instructions to complete each step.

DOWNLOAD FEATURES LIST:**1. SPEED LIMITER**

The speed limiter feature is available on most vehicles see the tables below for vehicle verifications. This download feature will adjust the OEM speed limiter. This feature can be adjusted to a speed set higher or lower than the OEM speed limiter. The tables below display the range of adjustability for gasoline and diesel vehicles.

Before adjusting the OEM speedometer the GT will require an opt in; by selecting "Yes," to opt in the user agrees that the vehicle has tires, suspension, and any other necessary modifications rated for speeds in accordance with the adjustment made.

Gasoline Speed Limiter adjustment by make		
Make	Minimum	Maximum
Dodge	50 mph	200 mph
Ford/Lincoln	40 mph	126 mph
GM	50 mph	135 mph
Nissan	40 mph	180 mph

Diesel Speed Limiter adjustment by make		
Make	Minimum	Maximum
Dodge 5.9L	50 mph	200 mph
Dodge 6.7L	50 mph	200 mph
Ford 7.3L	NA	NA
Ford 6.0L	NA	NA
Ford 6.4L	NA	NA
GM 6.6L '02-'08	50 mph	135 mph

This Feature may not be available for every vehicle

2. CALIBRATE SPEEDOMETER

The Calibrate Speedometer feature is also available for many vehicles see the tables below for vehicle specific information. This feature is useful to correct the OEM speedometer which is reading inaccurate when an aftermarket tire size has been installed on a vehicle. The vehicle applications and adjustments capable are displayed in the tables below for gas and diesel applications.

Calibrating for any tire size over 35" may cause the on-dash ABS light to turn on.

Gasoline Tire Size Adjustment by Make		
Make	Minimum	Maximum
Dodge '04-'08	23"	45"
Ford/Lincoln	24"	35"
GM	25"	45"
Nissan	NA	NA

Diesel Tire Size Adjustment by Make		
Make	Minimum	Maximum
Dodge 5.9L	23"	44"
Dodge 6.7L	23"	44"
Ford 7.3L	NA	NA
Ford 6.0L'05-'07	31"	37"
Ford 6.4L	NA	NA
GM 6.6L'02-'08	25"	45"

This Feature may not be available for every vehicle

3. FORD AND LINCOLN GASOLINE VEHICLE SPECIFIC DOWNLOAD FEATURES

TRANSMISSION TUNING (AUTOMATIC TRANSMISSIONS ONLY):

Two different options exist for transmission tuning, choose to accept a Bully Dog Custom transmission tune or to leave transmission tuning stock.

Firm Tune - This tune will affect shift firmness and shift points. It is an optimized tune designed for performance.

Stock Tune - Choose this option to utilize the factory shift patterns.

TRANSMISSION SHIFT POINTS (AUTOMATIC TRANSMISSIONS ONLY):

This feature will raise or lower the point that the vehicle shifts from first to second gear, second to third gear, and third to fourth gear based on engine rpms. Adjust shift points from 4400 up to 5800 before each gear change in increments of 100 RPMs.

4. GM GASOLINE VEHICLE SPECIFIC DOWNLOAD FEATURES

TRANSMISSION FIRMNESS* (AUTOMATIC TRANSMISSIONS ONLY):

This feature will turn up the pressure in the transmission so that shifts feel solid. It also helps reduce transmission slippage under heavy stress.

Performance: Pressure is greater than tow and stock. This setting is recommended to be used in combination with, but is certainly not limited to the High Performance Horsepower program.

Tow: Shifts are firmer than stock and less firm than High Performance. (This setting not available on '07-'08 models).

Stock: Does not change or modify transmission settings.

TRANSMISSION SHIFT POINTS* (GM VEHICLES AUTO ONLY):

This feature will adjust the point in the RPM range in which the transmission upshifts or downshifts.

'99-'EARLY '07 VEHICLES

Performance: Shifts at a higher RPM than Stock and Tow. This setting is recommended to be used in combination with, but is certainly not limited to the High Performance Horsepower Program.

Tow: Shifts at a higher RPM than Stock and shifts at a lower RPM than High Performance.

Stock: Does not modify shift points

LATE '07-'08 VEHICLES

There are two shift point options available for the '07-'08 vehicles:

Performance - This is a pre-established shift point tune. It is a tune that is setup for the average user, and offers an enhanced shift pattern.

Custom - Choosing the custom tune setting allows the user to setup custom shift points. Setting up custom shift points requires 3 steps:

1. Choose Rev Limiter.
2. Choose shift point from 1st to 2nd gear.
3. Choose shift point from 2nd to 3rd gear.

GM GASOLINE VEHICLE SPECIFIC DOWNLOAD FEATURES (CONTINUED)

CALIBRATE OEM SPEEDOMETER FOR GEAR RATIO (AUTOMATIC TRANSMISSIONS ONLY):

If no gear ratio modifications have been made to the vehicle then choose the stock setting when the tuner prompt appears to choose a gear ratio. This will ensure that no modifications are made to the stock program.

Adding a different gear ratio than the stock OEM tire size will cause the speedometer to read incorrect speeds. The Triple Dog Tuner can calibrate the OEM speedometer to read correctly for the following gear ratios:

- 3.23
- 3.42
- 3.73
- 4.10
- 4.56

5. DODGE 5.9L CUMMINS '03-'07 DIESEL VEHICLE SPECIFIC DOWNLOAD FEATURE

LOW END POWER (AUTOMATIC TRANSMISSIONS ONLY)

This feature is a simple opt in or opt out feature, it will improve throttle response on the bottom end of the rpm range. The result will be more horsepower and torque at lower RPM ranges. This feature is not recommended for everyday use.

6. DODGE GASOLINE VEHICLE SPECIFIC DOWNLOAD FEATURE

TRANSMISSION SHIFT POINTS ('04-'08 AUTO ONLY):

This feature allows you to raise or lower the point that the vehicle shifts from 1st to 2nd gear, 2nd to 3rd gear, and 3rd to 4th gear based on engine rpms. Adjust shift points from 5600 up to 6300 before each gear change in increments of 20 RPMs.

7. NISSAN GASOLINE VEHICLE SPECIFIC DOWNLOAD FEATURE

REV LIMITER (TOP ENGINE SPEED):

The Rev Limiter regulates the highest RPM that an engine can reach before the engine is electronically limited. The Rev Limiter is set to a lower point from the factory than what the Power Pup can set into the motor. Use the Power Pup to raise the Rev Limiter as high as 6400 RPM. The Rev Limiter can be adjusted from 6400 rpm down to 3000 rpm in increments of 25 rpm.

This features is mainly recommended for racing purposes, as it will enable the vehicle to shift at a higher RPM.

WIDE OPEN THROTTLE DISABLE (WOT):

Wide open throttle refers to a throttle position governor placed on stock Nissan vehicles. It limits the driver from using 100% of the vehicle throttle from 0-40 mph. Bully Dog's Wide Open Throttle feature will remove this governor from the vehicle.

WARNING: using this vehicle option is at the risk of the vehicle owner.

Bully Dog recommends that this feature be used for drag racing purposes only and should only be used on a designated drag race vehicle on a sanctioned drag racing track. Removing Wide Open Throttle will place added stress on drive train components, Bully Dog will not be held responsible for damages incurred as a result of the use of this feature.

If you press "Y" to modify the WOT restriction then tuner will display a second WOT screen. On this screen Press "Y" to enable WOT. Press "N" to disable or remove WOT restriction from the vehicle. After you select "Y" or "N" the tuner will continue through the download sequence.

If you press "N" to use the "Stock" settings then the tuner will continue through the download sequence.

Changing Download Settings/ Returning To stock settings:

To return the vehicle to stock or to change any of the Download settings: Engine Tune, Speed Limiter, or Tire Size follow the steps below.

1. Select Install Download from the main menu
2. Follow the screen prompts on the tuner screen.
3. If a download is entered on the vehicle the GT will display the following prompt:

Select "Y" to Change settings

Select "N" to return to stock

Each option will require that a download be performed, it is important to take all necessary download precaution when performing either task including removing fuses while the download is taking place.

Transferring to a new vehicle:

The GT is transferable to a new vehicle, but only after the original vehicle has been returned to stock and the product is fully uninstalled.

GAUGE SETUP

Enter to change the vehicle parameters (PIDs) displayed on the four gauge locations in the Main Screen. To see a list of all vehicle parameters available see the following page for parameters and descriptions.

Selecting a vehicle parameter to display in a particular location is done by highlighting the gauge location and then highlighting the desired vehicle parameter.

Once the correct vehicle parameter for a gauge location has been highlighted, you do not need to press another button to select that vehicle parameter. Simply highlighting the vehicle parameter makes it active in that location.

Notice that upon entering the gauge setup menu that, Set Gauge 1, is highlighted in black. When a gauge location is selected it is highlighted in black on the left and it also appears above the vehicle parameter selection box.

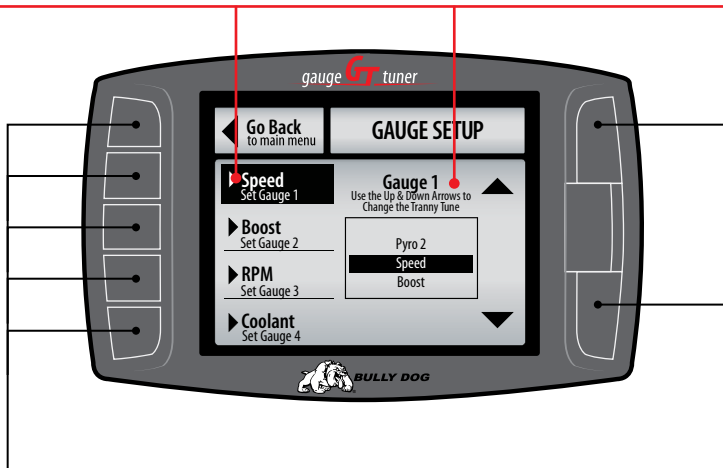

To highlight a different gauge location press the selection button that coincides with that gauge location. So to select gauge location 1, press the second button down on the left hand side of the GT. To select the 4th gauge location press the bottom button or the 5th button down on the left side.

Use the large Up▲ Down▼ Buttons to highlight a particular vehicle parameter for any of the gauge locations.

VEHICLE PARAMETERS

This diagram shows vehicle parameters which can be displayed on the GT. Due to vehicle specific availability not all of the parameters display below will be available on every vehicle. Notice that some vehicle parameters are specific to either gas or diesel vehicles.

Special Note: Pyrometer Temperatures (pyro 1 and 2) or Exhaust Gas Temperatures are available on all '07.5 and newer diesel pickups that are equipped from the OEM with a diesel particulate filter, See the appendix for more information on these vehicles. For all other vehicle applications pyrometers can be installed, a Bully Dog pyrometer is required for use with the GT and is the only pyro that will work with the GT.

PARAMETERS	Gasoline Vehicles	Diesel vehicles w/o DPF	Diesel vehicles w/DPF
Real Time Fuel Economy	X	X	X
Pyro 1 (exhaust gas temp)	Optional Upgrade	Optional Upgrade	X
Pyro 2 (exhaust gas temp)	Optional Upgrade	Optional Upgrade	X
Boost Pressure		X	X
Speed	X	X	X
RPM	X	X	X
Coolant	X	X	X
Fuel Pressure	X		
Fuel Rail Pressure		X	X
Manifold Absolute Pressure	X	X	X
Timing Position in degrees	X	X	X
IPW (injection pulse width)		X	X
Throttle Position	X	X	X
Intake Temperature	X	X	X
Mass air flow (grams/sec)	X	X	X
Barometer	X	X	X
Battery Voltage	X	X	X
Oil Temperature		X	X
ICP (injection control pressure)		X	X
Transmission Temperature		X	X
Load	X	X	X

DRIVING COACH SETUP WIZARD

For the driving coach to work properly it must be calibrated to the vehicle application in use. Select the Driving Coach Setup from the main menu and then follow the on screen instructions for guidance through the setup process. The Driving Coach Setup Wizard will ensure that the results displayed on the driving coach screen are accurately calibrated to the vehicle.

ATTENTION: The final step in the Setup Wizard does require that the vehicle be driven up to 60 mph to perform a drag calculation test. This test ensures that the Driving Coach feature is calibrated for each particular application. This test should only be performed on a straight and flat road on a day when wind speed is zero or near zero. Be sure that the road used for calibration has a speed limit of at least 60 mph.

DRIVING COACH SETUP WIZARD:

To start the wizard select "Driving Coach Setup," from the main menu and the press "Next," on the Welcome Screen.



To continue to step 2 simply press the "Next," button.



Driving Coach Setup continues on the next page...

STEP 1: ENGINE DISPLACEMENT: Choose Engine Displacement in liters, refer to vehicle owners manual.

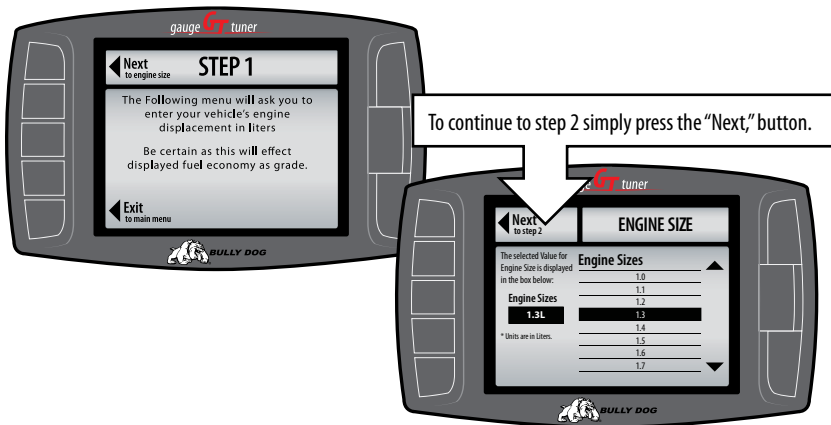

STEP 2: UNITS OF MEASURE: Choose preferred units of measure: English, or Metric units.

- **English** units will display fuel economy in miles per gallons, gallons per hour and will display temperatures in Fahrenheit.
- **Metric** units will display fuel economy in kilometers per liter, liters per hour and will display temperatures in Celsius.

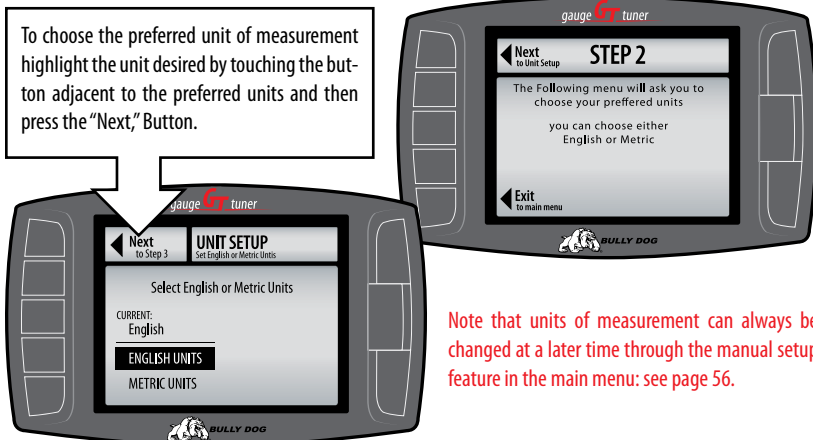

Note that units of measurement can always be changed at a later time through the manual setup feature in the main menu: see page 56.

STEP 3: CHOOSE CURB WEIGHT OF VEHICLE The curb weight of a vehicle is usually posted on a sticker on the inside of the drivers door jam. If the curb weight cannot be found on the door jam, refer to the vehicle owners manual or look for the curb weight on the internet. The vehicle can also be weighed on a vehicle scale.



To select the correct curb weight scroll to the correct value listed using the buttons on the right side of the GT then press the "Next," button to proceed to step 4.

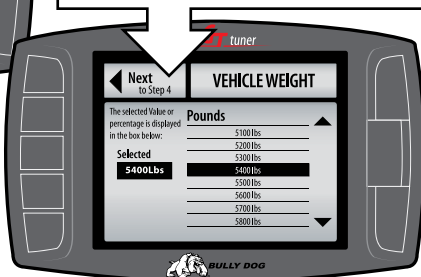

STEP 4: SELECT VEHICLE FUEL TYPE In step four simply select the vehicle fuel type: gasoline or diesel.

To choose the correct fuel type highlight the correct fuel type by touching the button adjacent to the preferred units and then press the "Next," Button.

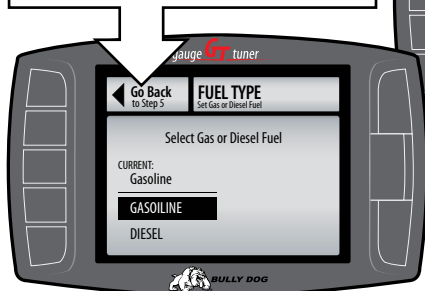
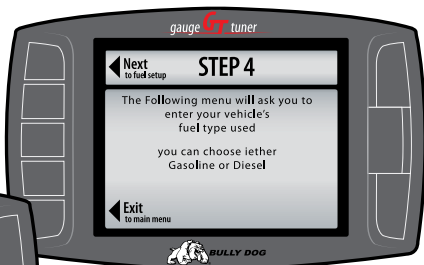

STEP 5: COMMUNICATION PROTOCOL

The GT will automatically determine the correct communication protocol to communicate with the vehicle. This step simply ensures that the GT is properly communicating with the vehicle.

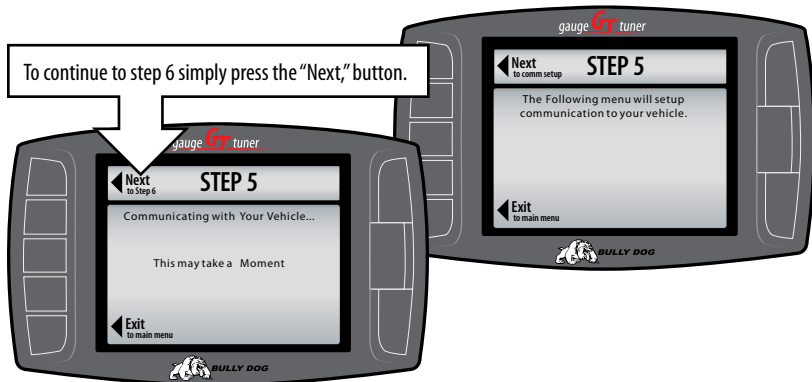

STEP 6: VERIFY SETTINGS/ SETUP COMPLETE

In this step the GT displays the options you have selected in the previous steps. Once you have verified the information to be complete simply press "Exit Main Menu" to complete the process.

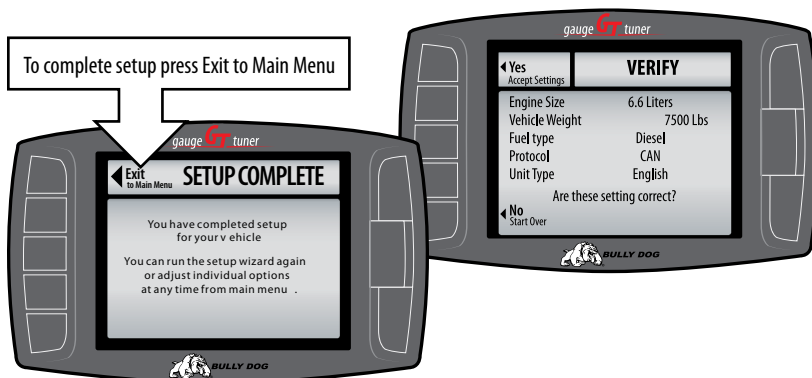

USER OPTIONS

In this sub menu you get to personalize your GT. The descriptions for all the user options are below. A more detailed description of each is on the following pages.

- **ADJUST BACKLIGHT:** Change screen backlighting for day and night driving.
- **SET SCREEN COLORS:** Choose between many different color setting themes.
- **ADJUST VOLUME:** Set button feedback volume.
- **CALIBRATE SPEEDO:** Calibrate speedometer for aftermarket tires & wheels
- **CALIBRATE ECONOMY:** Calibrate for vehicle characteristics.
- **ENGLISH/METRIC UNITS:** Choose units of measurement
- **RESET TO DEFAULT SETTING:** Revert back to Bully Dog factory settings.

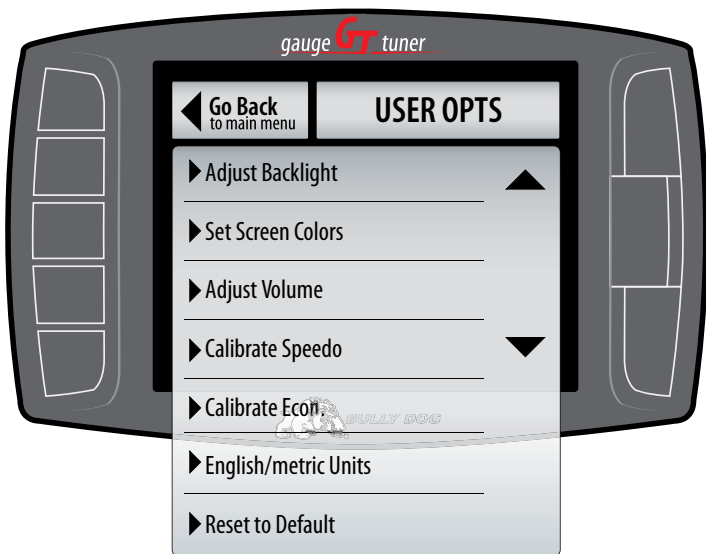

BACKLIGHTING ADJUSTMENT:

The *backlighting* for the GT can be set for both a Day and Night mode. The GT switches between day and night modes based on whether the vehicle head lights are turned on or off. If the vehicle headlights are turned off the GT backlighting will switch to day mode settings, if the lights are on the backlighting will switch to night mode settings. See the diagram below for an illustration of the “Backlighting Menu,” items.

Once day and night mode settings are set to the preference of the driver, simply touch the “Go Back,” button to exit this menu and the settings will automatically take effect.

simply exit the menu and the selection will automatically take effect.

Use these buttons to select either screen brightness or Day/Night mode

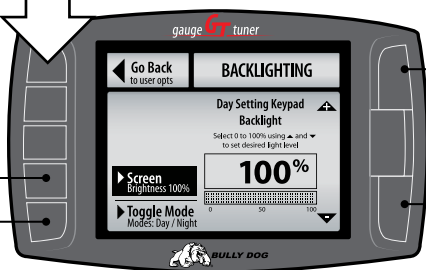

Use the Up & Down arrow keys to adjust the total percentage of light emitted by the screen in either Day mode & Night mode.

SCREEN COLORS

There are over a dozen to choose from and many more will be added. The GT color theme will change as a new theme is highlighted to provide a preview.

Exit the menu and the selection will automatically take effect.



Use the large Up ▲ Down ▼ Buttons to scroll up and down through the color options.

AUDIO FEEDBACK ON/OFF

The audio on the GT is either on or off, highlight the button adjacent to the on or off area on the screen to turn audio on and off.

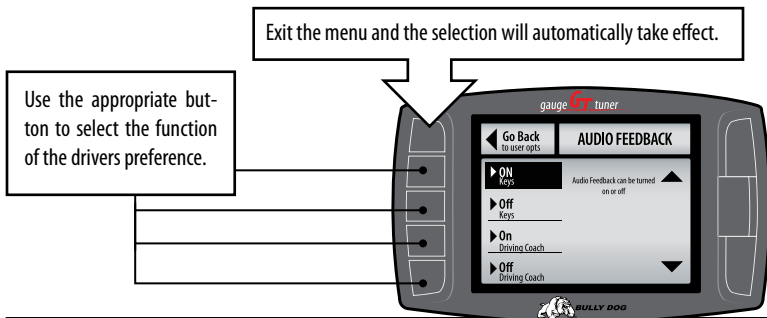

CALIBRATE SPEEDO

Allows the user to adjust the GT to allow for aftermarket tires and wheels.

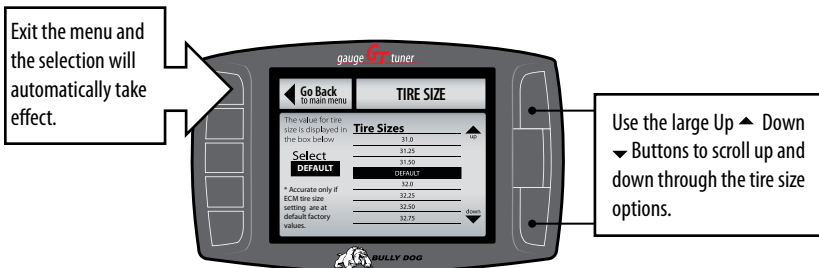

CALIBRATE ECONOMY.

Calibrate for vehicle characteristics.

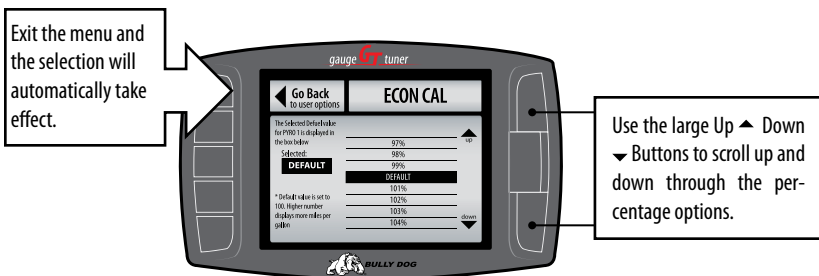

ENGLISH/METRIC UNITS

The GT contains the ability to display vehicle parameters and fuel economy in either Metric units or English standard units.

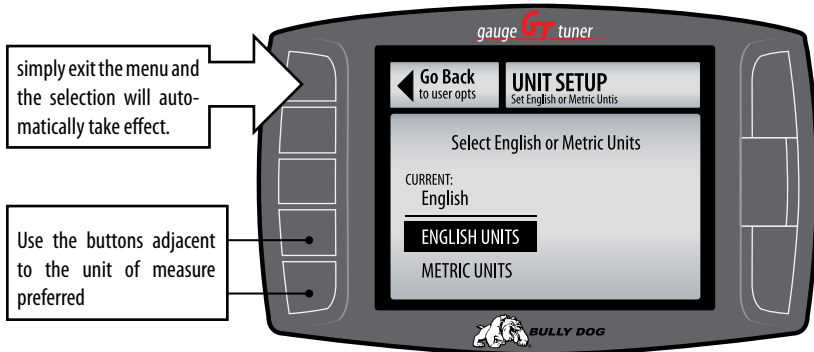

RESET TO DEFAULT SETTING

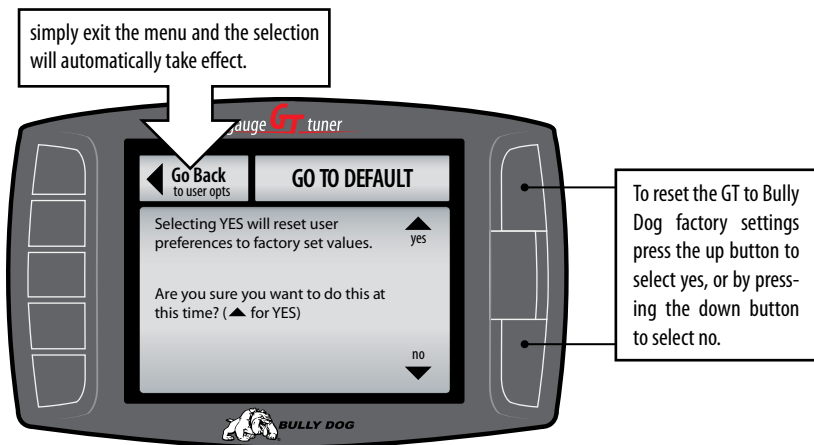

VEHICLE OPTIONS:

In this sub menu you get to manually setup the parameters that the Driving Coach uses to calculate fuel economy and wasted energy. These parameters can also be setup in the Driving Coach Setup Wizard. The descriptions for all the vehicle options are listed below. A more detailed description of each is on the following pages.

INCLUDES:

- **ENGINE SIZE (DISPLACEMENT):** Enter the engine size in liters.
- **VEHICLE WEIGHT:** Enter vehicle curb weight.
- **FUEL TYPE:** Enter either gasoline or diesel
- **COMMUNICATION PROTOCOL:** Enter the communication style used on the vehicle.

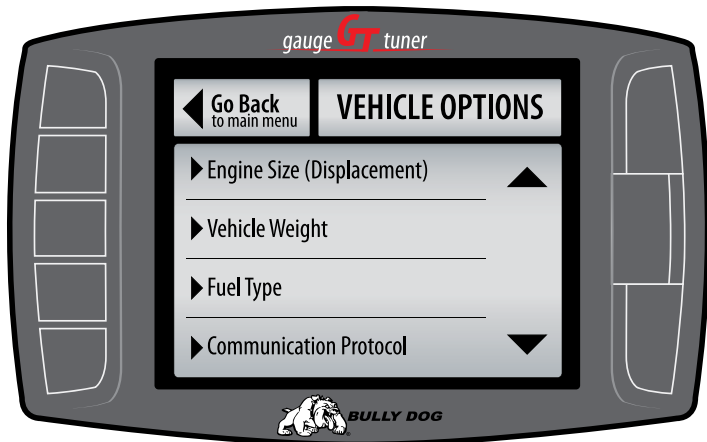

ENGINE SIZE (DISPLACEMENT)

Choose the correct engine size or displacement to help calibrate the driving coach to work correct with the vehicle application.

Once the correct displacement is highlighted press the "Go Back" button to continue.

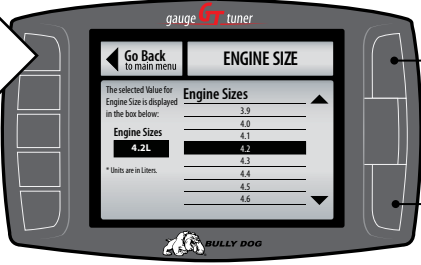

To select the correct displacement amount use the two capacitive buttons on the right side of the GT to scroll up and down. Highlight the correct displacement.

Engine Sizes
3.9
4.0
4.1
4.2L
4.4
4.5
4.6

VEHICLE WEIGHT

Choose the correct vehicle weight to help calibrate the driving coach to work correct with the vehicle application.

The curb weight of a vehicle is usually posted on a sticker on the inside of the drivers door jam. If the curb weight cannot be found on the door jam, refer to the vehicle owners manual or look for it on the internet. The vehicle can also be weighed on a vehicle scale.

Once the correct Weight is highlighted press the "Go Back" button to continue.



To select the correct curb weight scroll to the correct value listed using the buttons on the right side of the GT .

Pounds
5100 lbs
5200 lbs
5300 lbs
5400Lbs
5500 lbs
5600 lbs
5700 lbs
5800 lbs

FUEL TYPE

Specify the correct fuel type to help calibrate the driving coach to work correct with the vehicle application.

Once the correct fuel type is highlighted press the "Go Back" button to continue.

Use the buttons adjacent to the preferred fuel type.

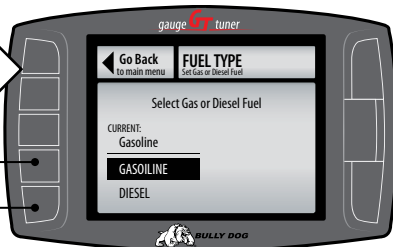
**COMMUNICATION PROTOCOL**

The GT will automatically establish communications with the vehicle.

Once communications have been established, press Exit to return to main menu.

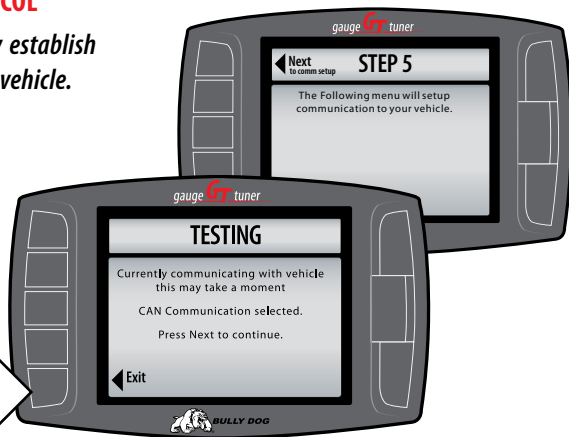

DEFUELING PARAMETERS (DIESEL VEHICLES ONLY)

Set up defueling parameters based on a number of different vehicle parameters. In this menu you can also turn defueling for vehicle parameters off. The defueling parameters available are vehicle specific, so not all defueling parameters are available for every make and model.

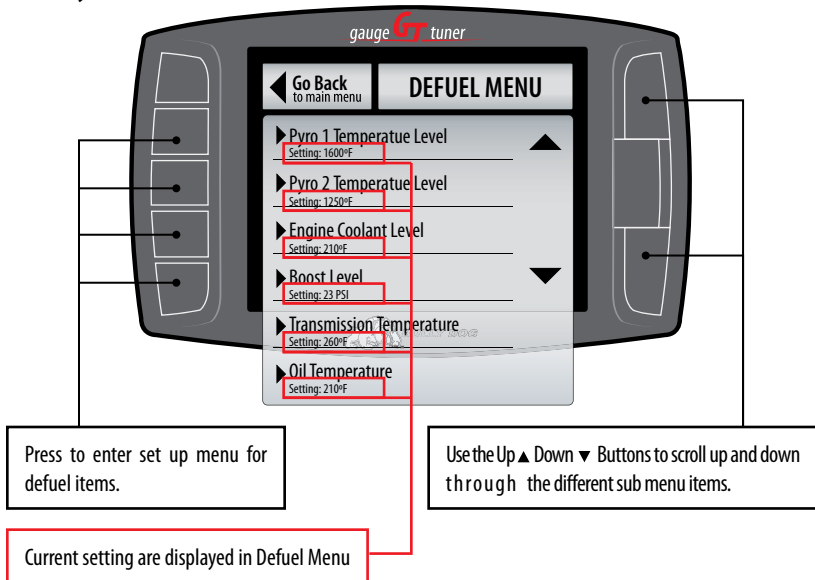

Below is a list of all of the defueling capabilities for the GT. All defueling options can be activated at the same time, all can be turned off, or a mix of on and off. Each defueling option is adjusted individually to be on or off and set to a particular defueling temperature.

Defueling Features	Default Settings
Pyro 1 Temperature Level	1250°F
Pyro 2 Temperature Level	OFF
Engine Coolant Temp Level	220°F
Boost Level	OFF
Transmission Temp Level	OFF
Oil Temperature*	OFF

Pyrometer Calibration Procedure:

When setting pyrometer defueling levels it is important to use our pyrometer calibration procedure to know what temperatures should be set. See the pyrometer calibration procedure in the appendix of this manual.

SET DEFUEL LEVELS:

When entering a setup menu for any of the defuel options the menu will have a list of defuel levels to select from based on that specific defuel parameter. The selected value is displayed on the left, to select a defuel level highlight the amount and then exit the setup menu. To turn any particular defuel parameter off press the bottom left button.

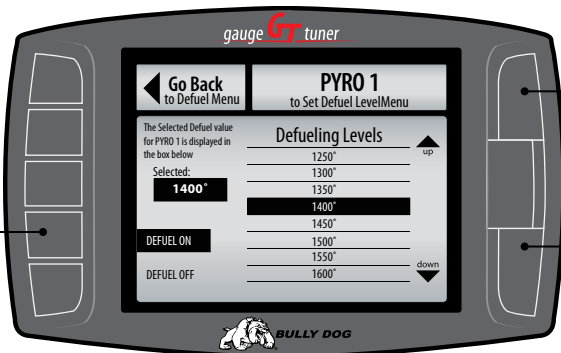

Use this button to turn the defueling on

Use the Up ▲ Down ▼ Buttons to scroll up and down through the different sub menu items.

Use this button to turn the defueling OFF



MOBILE DESOOT (DODGE 6.7L CUMMINS '07.5-'09 VEHICLES ONLY)

The mobile Desoot feature will send a request to the vehicle to start the Desoot process of the diesel particulate filter. This feature should only be used if the diesel particulate filter gets clogged and will not go into mobile Desoot mode. Follow the on screen instruction provided by the GT.

Notice: Mobile Desoot function should only be used if absolutely necessary. If the diesel particulate filter clogs often on a particular vehicle it may be an issue with the particulate filter itself and it may need to be serviced by an OEM dealer.



DPF BURN-OFF (GM 6.6L DURAMAX '07.5-'09 VEHICLES ONLY)

The DPF Burn-off feature will send a request to the vehicle to start the DPF burn-off of the diesel particulate filter. This feature should only be used if the diesel particulate filter gets clogged and will not go into mobile Desoot mode. Follow the on screen instructions provided by the GT.

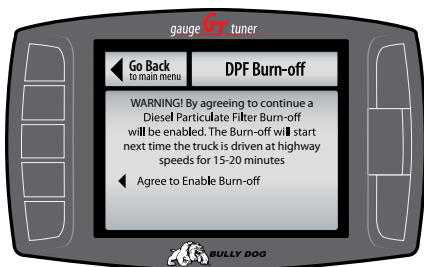

Notice: The DPF burn-off function should only be used if absolutely necessary. If the diesel particulate filter clogs often on a particular vehicle it may be an issue with the particulate filter itself and it may need to be serviced by an OEM dealer.

SPECIAL FUNCTIONS (DODGE GAS AND DIESEL VEHICLES ONLY)

The special functions are available for use only on the Dodge vehicles. These functions can be performed at any time. The descriptions below tell what each function does to the vehicle.

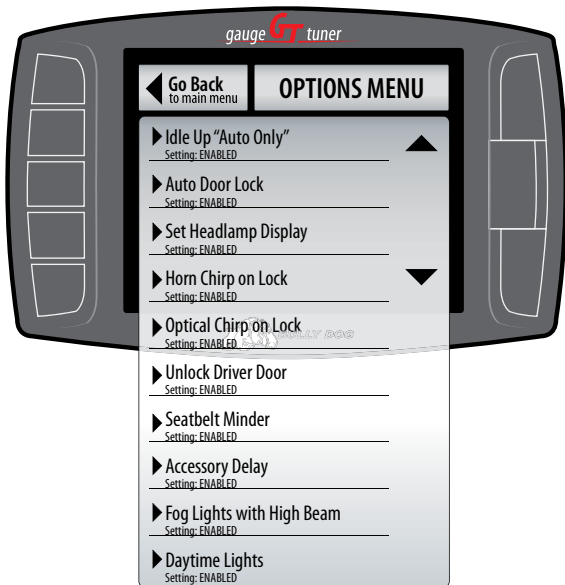
**AUTO DOOR LOCK**

Enabling this feature will cause all doors to lock once the vehicle reaches a speed of 15 mph. Once the vehicle comes to a complete stop, if the driver's door is the first to open all of the other doors will automatically unlock.

HEAD LAMP DELAY

Use this feature to set the amount of time that the head lamps remain on after the vehicle has been turned off. Use the up/down arrows on the tuner to scroll in 5 second increments between 0 and 80 seconds.

SPECIAL FUNCTIONS (CONTINUED)

FOG LAMP

Enabling this feature will allow the fog lights and high beams to operate at the same time. This feature is for Off-road use only.

HORN CHIRP ON LOCK

Enabling this feature will sound a horn chirp each time the doors are locked when using a remote door lock system.

OPTICAL CHIRP ON LOCK

Enabling this feature will flash the hazard lights each time the doors are locked when using a remote door lock.

SEAT BELT MINDER CHIME

Enabling this feature will remind the driver to buckle their seat belt with an audio chime each time the vehicle is put into drive and the driver's seat belt is not buckled.

ACCESSORY DELAY

Use this feature to set the amount of time that the accessory items in the vehicle will remain on after the vehicle has been shut off as long as the doors remain closed. Accessory items include the radio, cigarette lighter, etc. Use the up/down scroll buttons on the tuner to choose between the following settings: 0 seconds, 45 seconds, 5 minutes, 10 minutes, 30 minutes, or 60 minutes.

UNLOCK DRIVER DOOR

Enabling this feature will affect the way the doors unlock when using a remote door lock. If enabled, the first time the remote unlock button is pressed only the driver door will unlock, the second hit will unlock the passenger doors. If disabled, all doors will unlock on the first press of the remote unlock button.

DAYTIME HEADLIGHTS:

Use this new option to turn daytime running lights on or off while driving.

TRANSMISSION TUNE: **FORD 6.0L POWER STROKE '03-'07 ONLY**

This allows you to set a specific transmission tune style for each on-the-fly power setting. There are three transmission tune styles available: stock, smooth, and aggressive. Not all of the tunes are available for every power setting.

Notice that upon entering the transmission tune menu that, Extreme, is highlighted in black. When a Power level location is selected it is highlighted in black on the left and it also appears above the transmission tune selection box.

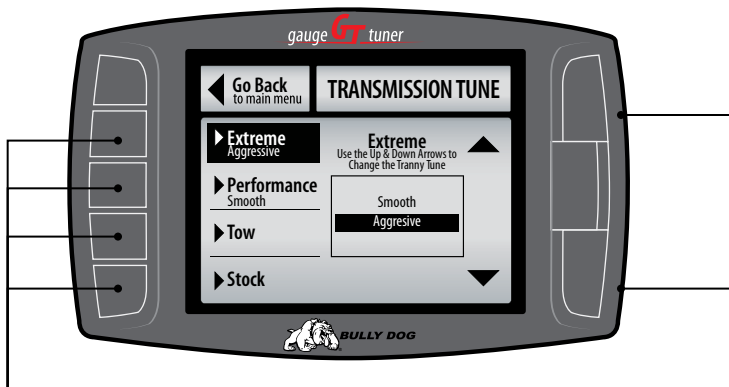

Use these buttons to select the power level for which you want to set the transmission tune.

Use the Up ▲ Down ▼ Buttons to scroll up and down through the different transmission tunes.

ADJUST TIRE SIZE

The tire size function allows you to adjust the speed that the GT will display in one of the gauge locations to account for larger or smaller than stock tire sizes. The range of tire sizes that the GT will adjust for starts at 28" and goes up to 39" and it adjusts in increments of .25".

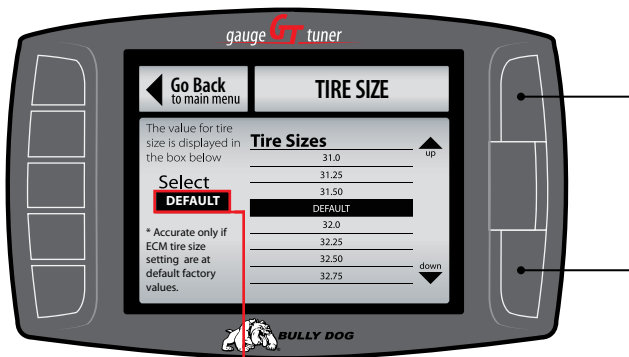

Notice that the selected tire size is displayed in the box on the left side of the screen. Once the correct speed is highlighted simply press the go back button to exit. Your selection will automatically be saved.

Use the Up ▲ Down ▼ Buttons to scroll up and down through the available tire sizes; highlight the tire size that fits what is currently installed on the vehicle in order for the GT to display the accurate speed.

DEFAULT SETTING:

The default setting reads the speed directly off of the vehicle's computer. Use this setting if you have already calibrated the speedometer for larger or smaller aftermarket tires.

DIAGNOSTICS

This sub menu allows you to check vehicle Diagnostic Trouble Codes (DTCs). Upon entering this menu, the GT will automatically begin to check the vehicle for DTCs and it will then display those DTCs on the GT screen. Once it displays the DTCs value and description on the screen it will allow you to erase the DTCs from the vehicle.



If no DTCs are displayed you can simply press the Go Back button to return to the main menu.



SHOW SETTINGS:

The Show Settings Menu will allow you to see vehicle information and also defuel settings. See the diagram below to see everything that is listed in this menu.

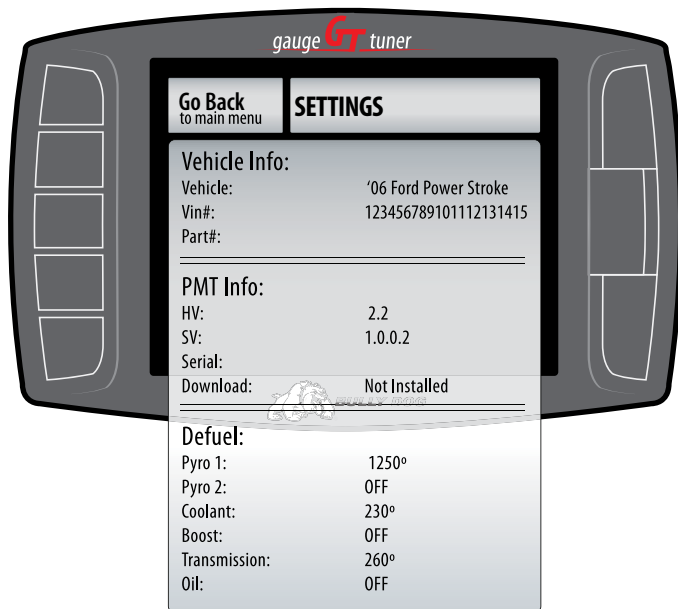

UPDATE GT SOFTWARE

This sub menu is only used when a new internet update becomes available or if an installation or download issue needs to be trouble shot. Before this function is used an internet update must be performed through the Bully Dog Update Agent. This will be used only after an internet update has been performed. See the internet updating instructions in the appendix of this manual.



To update the GT software simply press the up arrow on the right side of the GT to which is located adjacent to the up arrow seen on the GT screen.

The GT will take a minute to update the software, please wait patiently while the applications loads into memory. If there are new features available look on our web site for a description of those features.

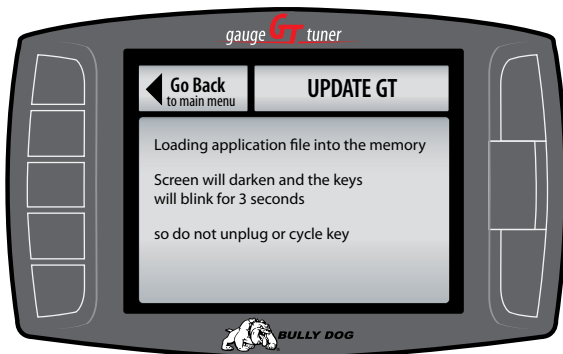

UPDATE GT SOFTWARE (CONTINUED)

The two scenarios below depict a couple of common errors seen when updating the GT software.

NO SD CARD NOTICE: The screen capture below illustrates what will be seen on the screen if an update is attempted without the GT micro SD card in the SD card slot.



IDENTICAL FILE NOTICE: If an internet update was unsuccessful then the Update GT Software function will display that the GT contains the same information, and no new information was added. If this happens check the version information of the current software loaded on the GT, in the show settings menu, and compare that to what is available online.

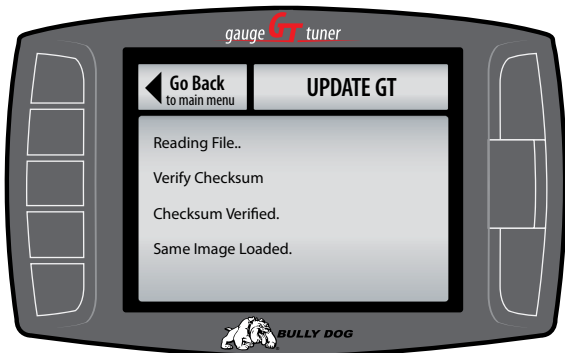

PART 3

Internet Updating

Internet Updates: There are three sections in the internet updates portion of this manual, each section is important to understanding and performing internet updates on the GT.

SECTION 1: GT Version Information

Before performing an internet update it is important to know how the version system works. Based on the change in version numbers between the current version on the GT and the version that is available on the Bully Dog web site the GT may have to be returned to stock. SEE section 1 for details.

SECTION 2: The Update Agent

This is Bully Dog's exclusive software program developed to update Bully Dog products via the internet. This software is required to update the GT. Section 2 will explain how to use get the Update Agent..

SECTION 3: The Update Process

This section explains how to update the GT step by step.

UPDATE INSTRUCTIONS PGS. 72-74

Section 1: GT Version Information pg. 72

Section 2: The Update Agent pg.73

Section 3: The Update Process pg.74

SECTION 1: GT VERSION INFORMATION

The GT may have to be returned to stock before an internet update can be performed based on the version information. Meaning that the GT download may have to be downloaded to factory stock. The change in the version number for any new update issued on the Update Agent can be viewed on the Bully Dog web site and compared to the version on the GT. This is how to determine if a download to stock is necessary.

The GT software versions contain four digits as seen below:

1.0.0.0

If any of the first three digits change in the version number then the GT must be downloaded back to stock before an internet update.

If the fourth digit is the only digit that changes on a newly issued GT version then the GT does not need to be downloaded back to stock.

Show Settings Menu: Navigate to the show settings menu in the GT main menu to find and view the Software Version currently loaded on the GT.

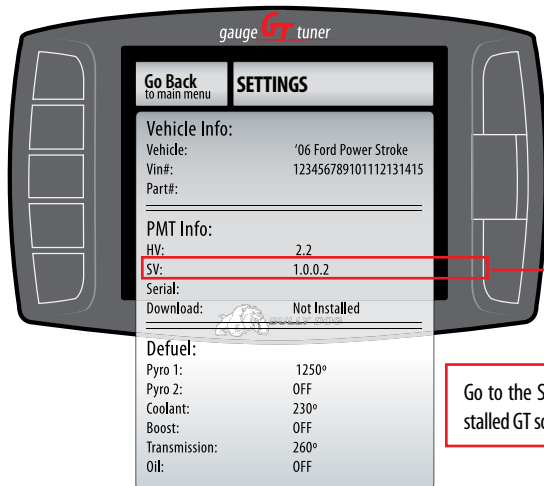

Go to the Show Setting Menu to view current installed GT software version.

SECTION 2: THE UPDATE AGENT

The GT can only receive internet updates through the Update Agent. Therefore, internet updates must be performed on a PC with a strong internet connection. The Update Agent is a software program developed by Bully Dog Technologies specifically designed to update Bully Dog products. The Update Agent is easy to use, it can be loaded on any windows based PC running Windows XP or newer. The Update Agent is attainable free of charge at the Bully Dog Download Center or by ordering a CD ROM through a Bully Dog distributor.

HOW TO GET THE UPDATE AGENT

1. To download the Update Agent through our web site visit: www.bullydog.com/download_center.php . This address will take you to the Bully Dog download center where a free copy of the Update Agent can be downloaded.
2. A free copy of the Update agent can also obtained by requesting an Update Agent CD.
3. For assistance with downloading or installing the Update Agent call technical support at: 866-285-5936.

SECTION 3: THE UPDATE PROCESS

Follow the steps listed below to update the GT software to the latest version.

1. Plug the GT into a PC that has a high speed internet and is loaded with the Update Agent 2.0 using a mini USB cable. SD card must be installed in the GT.
2. Once the GT is plugged into the PC via USB the Update Agent will automatically recognize the SD card and open to the following screen on your computer.
3. From this screen there is only one simple thing to do; press the update button on the right hand side of the screen and the Update Agent will automatically update the GT software.
4. When the Update Agent finishes updating the GT software the GT can be remove from the PC and the USB cable.
5. Reinstall the GT into the vehicle via the Main Harness and mounting device.



6. Once installed turn the ignition to the on position, but do not start the engine. The GT will light up to display the main screen.

7. Navigate from the main screen into the Main Menu and select Update GT Software.

7. Follow the screen prompts to update the GT, do not unplug while performing the GT update.

8. Once the Update Software function has completed, the GT can be used like normal.



PART 4

Appendix

The appendix contains important information for the GT and is split into four sections.

SECTION 1: Pyrometer calibration procedure

SECTION 2: Transmission relearn procedures: Ford & GM

SECTION 3: OEM pyrometer locations

SECTION 4: Troubleshooting/error codes

SECTION 5: Formatting SD Card

APPENDIX..... PGS. 75-79

Section 1: Pyrometer Calibration pg. 76

Section 2: Transmission Relearn pg. 77

Section 3: OEM Pyrometer Locations..... pg. 78-79

Section 4: Troubleshooting/Error Codes..... pg. 81

Section 5: Formatting SD Card pgs. 82-83

SECTION 1: Pyrometer calibration procedure

BEFORE THIS STEP CAN BE COMPLETED, COMPLETELY INSTALL THE GT AND ALL OF ITS COMPONENTS.

1. Vehicle must be set to Stock HP/TQ levels-meaning no HP/TQ modifications of any kind (tuner or plug-in modules).
2. Engine must be put under full load for as long as possible on the hottest day possible. It is suggested to drive up a hill or pull a trailer.
3. During a heavy load pull, record the highest reading.
4. Take that reading and add 150° to the high number and that will be your new defuel number that you do not want to exceed.

SECTION 2: Transmission Relearn Process

After completing the download process, it is recommended on a 6.6L Duramax with an automatic Allison and a 6.0L Ford Power Stroke with an automatic Torque Shift transmission, that the transmission be relearned. Relearning the transmission can help the transmission adjust to the higher levels of power offered by the GT resulting in a better shifting transmission. Follow the vehicle specific procedures below to relearn the following transmissions.

GM 6.6L DURAMAX WITH ALLISON TRANSMISSION

1. At a $\frac{1}{4}$ throttle get up into 5th gear. Once you are in 5th gear, apply light pressure to the brake pedal until the truck is stopped.
2. At a $\frac{1}{2}$ throttle get up into 5th gear. Once you are in 5th gear, apply light pressure to the brake pedal until the truck is stopped.
3. At $\frac{3}{4}$ throttle get up into 5th gear. Once you are in 5th gear, apply light pressure to the brake pedal until the truck is stopped.
4. At full throttle get up into 5th gear. Once you are in 5th gear, apply light pressure to the brake pedal until the truck is stopped.
5. Go through the same process with the Tow Haul button on.

FORD 6.0L POWER STROKE AUTOMATIC TORQUE SHIFT TRANSMISSION

1. Come to a complete stop and put the tuner on its highest setting.
2. Moderately accelerate to 55 mph.
3. Allow the vehicle to shift into overdrive and while in overdrive, maintain a speed of 55 mph for 15 seconds.
4. Lightly apply the brake just enough to engage the brake lights, hold brake lights on while maintaining 55 mph for another 15 seconds.
5. Come to a complete stop for 20 seconds.
6. Repeat steps 3 through 5 five additional times.
7. Drive normally and enjoy.

SECTION 3: OEM Pyrometer Locations (vehicle w/DPF only)

PYROMETER LOCATION AND OVERVIEW:

The diagrams below shows where Pyro 1 and Pyro 2 are installed on the 2007.5 and newer light duty diesel trucks. There is no installation required for these pyrometers; each pyrometer is OEM. The temperatures at each location are displayed on the GT as a vehicle parameter under the gauge setup menu.

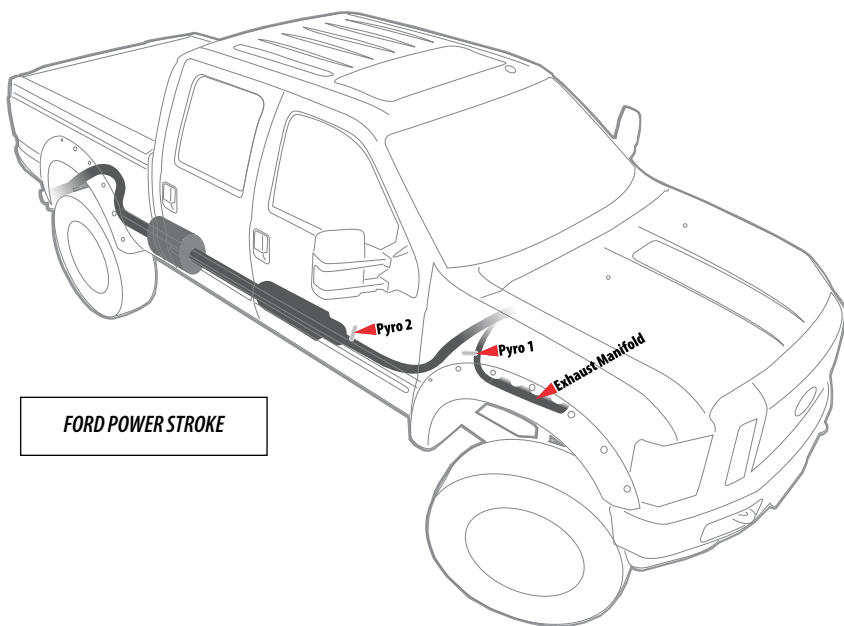

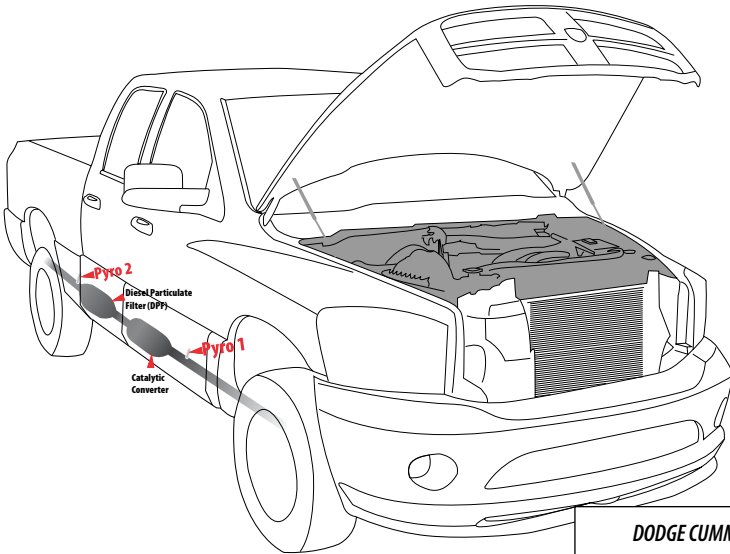

DODGE CUMMINS

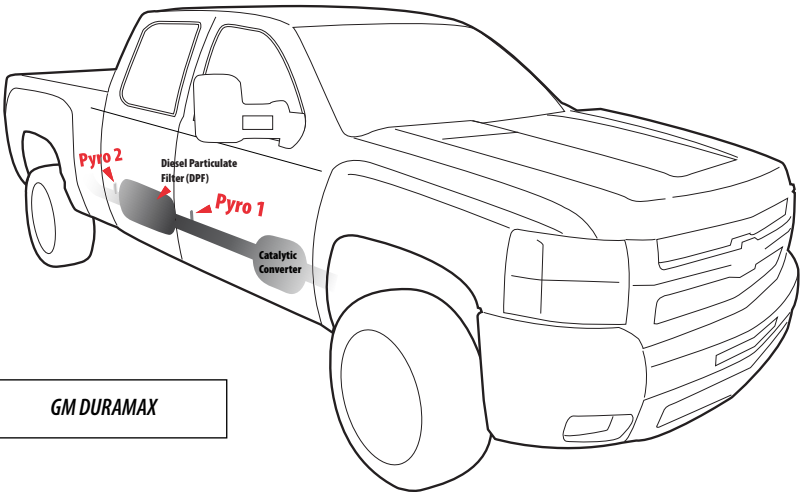

GM DURAMAX

SECTION 4: GT Troubleshooting

CONDITION	POSSIBLE SOURCES	ACTION
GT will not turn on	Installation/ Connections	Make sure that the fuse jack is securely fastened to the fuse socket.
		Check that the fuse is working properly.
		Make sure that all of the harnesses are properly installed. If still not working, one of the harnesses could be defective.
Will only display pyrometer	Improper Truck Selection	Check and ensure the proper truck is selected.
		Make sure you have proper connections everywhere. Also, make sure that there are no bent pins in any of the connectors.
Will not adjust horsepower	Improper Truck Selection	Check and ensure the proper truck is selected.
Back light quit working	Loose Connections	Contact Technical Support if the GT is otherwise functioning normal.

For more information on up-to-date troubleshooting guide for the GT, go to www.bullydog.com/Product_Updates.php

GT ERROR CODES:

For error code information regarding any error codes that appear while operating the GT visit the web address below:

www.bullydog.com/GT_Tech.php

SECTION 5: Formatting SD card

The SD card should only be taken out of the GT to perform internet upgrades. It is the primary means of performing internet upgrades for the GT.

In case an SD Card is lost or broken, a new SD Card can be purchased and used to update the GT. However, the new card will need to be formatted to work with our internet update software, The Update Agent. The reason a new SD card needs to be formatted is so that the Update Agent will automatically recognize that SD Card when the SD card is plugged into a PC. Below are steps and diagrams showing how to format a new SD Card:

1. Plug the SD Card into a PC via the USB to SD Card Reader.
2. Open the My Computer function in Microsoft windows to see all of the devices and drives on that PC. Find the new SD Card in the list under the heading, "Devices with removable storage."
3. Right click on the SD Card to show a drop down menu of options. In the drop down menu click on Format.

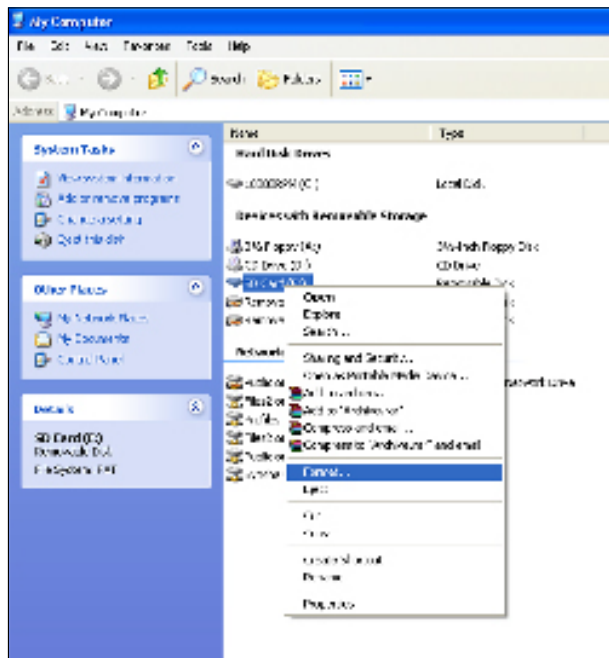

4. With the formatting dialog box open click the drop down men for "File System." Highlight and click on FAT.
5. Then change the Volume Label to read "Bully Dog," by typing it into the dialog box below that title.
- 6 Click "Start" to reformat the card with the new information.

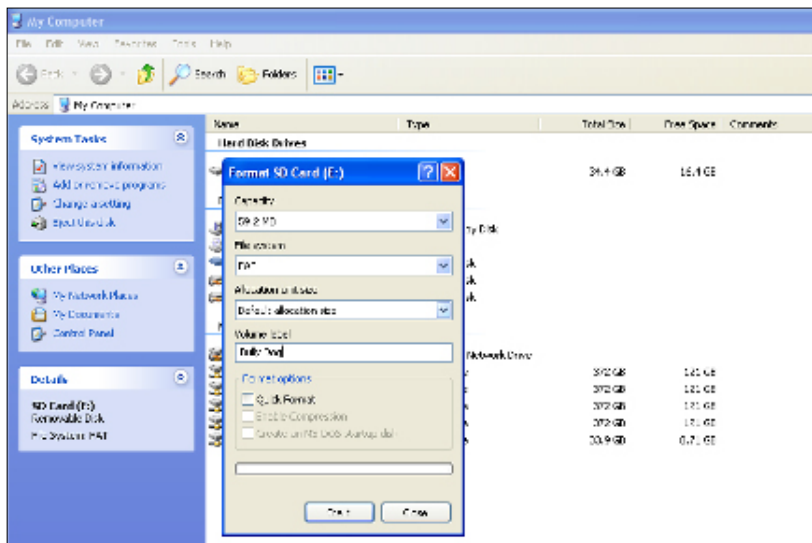

7. After the reformat process is complete you need to visit our web site to download a file that must be saved to the SD card. Visit <http://www.bullydogupdateagent.info/GTidf.bin> and save the file to the SD card. This file allows the Update Agent to identify the SD card as a GT SD card.
8. Now unplug the card reader and plug it back into the PC and the Update Agent should recognize this SD Card.

Now whenever this card is plugged into any PC that has the Bully Dog Update Agent installed the Agent will automatically recognize the SD Card.

GT featuring DRIVING COACH™ technology

The Driving Coach Software gathers information from the sensors that each vehicle is equipped with from the factory. The software then processes the information and uses that information to serve as the Driving Coach. It then instructs the driver to use the most economical driving techniques in order to maximize fuel economy.



- INCREASED fuel Economy
- Improved Driving Habits
- Real-time DRIVING COACH
- Set-up Wizard for YOUR Vehicle
- Vehicle Monitoring Functions
- Grading System
- Simple & Easy Installation

GASOLINE GT APPLICATIONS

FORD

- 4.0L (Mustang)
- 4.6L (Trucks, SUVs & Mustang)
- 5.4L (Trucks, SUVs)
- 6.8L (Trucks, SUVs & Motorhomes)

DODGE

- 5.7L (Ram)
- 6.1L (SRT 8) *Coming Soon*

GM

- 4.8L (Trucks, SUVs)
- 5.3L (Trucks, SUVs)
- 6.0L (Trucks, SUVs)
- 6.2L (Trucks, SUVs)
- 8.1L (Trucks, SUVs)

NISSAN/INFINITI

- 5.6L (Trucks, SUVs)
- 4.0L (Trucks, SUVs)
- 2.5/3.5L (Cars & SUVs) *Coming Soon*

DIESEL GT APPLICATIONS

FORD

- 7.3L (Trucks, SUVs) *Coming Soon*
- 6.0L (Trucks, SUVs)
- 6.4L (Trucks, SUVs)

DODGE

- 5.9L (Trucks, SUVs)
- 6.7L (Trucks, SUVs)

GM

- 6.6L (Trucks, SUVs)



Go to www.bullydog.com for all new vehicle applications coming monthly