

# JUICE ATTITUDE

CS/CTS

## *Edge GM Juice Supplement Installation Instructions*

**READ IMPORTANT SAFETY INFORMATION IN THIS MANUAL**



**EDGE**  
PRODUCTS

## **Table of Contents**

<b>IMPORTANT SAFETY INFORMATION</b>	<b>3</b>
<b>SAFETY TERMS</b>	<b>3</b>
<b>SAFETY GUIDELINES</b>	<b>3</b>
<b>PRODUCT REGISTRATION</b>	<b>4</b>
<b>Benefits of product registration:</b>	<b>4</b>
<b>About the Edge Juice</b>	<b>5</b>
<b>Power Levels</b>	<b>6</b>
<b>EGTs: What they mean and why</b>	<b>6</b>
<b>The Juice Module and your Transmission</b>	<b>7</b>
<b>Transmission Relearning</b>	<b>7</b>
<b>Connecting and Installing the Juice</b>	<b>7</b>
<b>Supplied Items:</b>	<b>8</b>
<b>Required Tools:</b>	<b>8</b>
<b>2001-2005 GMC Duramax 6.6L LB7 &amp; LLY</b>	<b>8</b>
Power Gains (2001-2005 GMC Duramax LB7 & LLY)	9
<b>2006-2007 GMC Duramax 6.6L LLY &amp; LBZ</b>	<b>10</b>
Power Gains (2006-2007 GMC Duramax LLY & LBZ)	12
<b>2007.5-2010 GMC Duramax LMM</b>	<b>12</b>
Power Gains (2007.5-2010 GMC Duramax LMM)	15
<b>Final Inspection</b>	<b>15</b>
<b>Install and Attach the EGT Probe</b>	<b>15</b>
<b>Attach the EAS JAB (Juice-Attitude Bridge)</b>	<b>19</b>
<b>Hot Unlock Code</b>	<b>24</b>
<b>Warranty Information</b>	<b>26</b>
<b>LIMITED 1 YEAR WARRANTY</b>	<b>26</b>
<b>Glossary of Terms</b>	<b>28</b>
<b>Technical Support:</b>	<b>28</b>

©2009, Edge Products Incorporated  
All rights reserved.  
Edge Products  
1080 South Depot Drive  
Ogden, UT 84404  
888-360-3343  
[www.edgeproducts.com](http://www.edgeproducts.com)  
Manual Revision 2

## IMPORTANT SAFETY INFORMATION

### SAFETY TERMS

Throughout this User Guide (hereafter referred to as User Manual or Manual) you will see important messages regarding your safety or the protection of your vehicle. These messages will be designated by the words WARNING or CAUTION.



**WARNING** indicates a condition that may cause serious injury or death to you, your passengers or others nearby. Pay careful attention to these Warning messages, and always comply with them. They could save a life.

**CAUTION** indicates a condition that could cause damage to your vehicle. It is important to install and operate your EDGE product in conformance with instructions in this Manual. Caution messages alert you to particularly important things to watch for to keep your vehicle operating the way you want it to.

The Edge product you have bought is a high-performance product. As such, it does present some risks of which you should be fully aware. Do not use this product until you have carefully read all the following safety information and the Owner Agreement.



**Misapplication or misuse of this product could lead to a serious or fatal accident. Comply with all safety information below, and in your vehicle owner's manual. Follow safety, installation and operating instructions in this User Manual to**

### SAFETY GUIDELINES

1. Do not exceed legal speed limits on public roadways. Use any enhanced speed capabilities of this product only in closed circuit, legally sanctioned racing environments expressly for this purpose. Loss of control from speeding on a public road could seriously injure you, your passengers, or others on the roadway.
2. Select a position on the windshield or dashboard to mount the device where it will not impair your view. You must be able to see the road, traffic, and pedestrians without interference. Be sure your mounting location meets state and local laws regarding placement of devices on the windshield or dashboard.
3. Do not operate the device while driving. Perform all adjustments or changes while stopped. Changing a setting while under way can interfere with your attention to roadway conditions.
4. "Stacking" performance-enhancing devices or other improper installation could cause powertrain failure on the road. Other products may have features incompatible with your Edge device. Follow all installation and operating instructions, and don't stack products.
5. Some modifications may affect other parts of your vehicle. For example, if you remove/adjust the speed limiter in your vehicle, be sure your tires and other components are rated for the increased speeds they will have to withstand. Not doing so can lead to loss of vehicle control. Modify the speed limiter only for use in closed circuit, legally sanctioned racing environments, not for use on public roadways.

6. Do not use the Performance Tests feature to break any traffic laws. Perform these tests only where they are legal and safe.
7. Some features may not function on all vehicle models. Check a newly-installed device for all features you intend to use. Do not rely on their working without checking first.

**NOTE:** *Dispose of this product consistent with local codes. Return to your electronics supplier for proper handling.*

## PRODUCT REGISTRATION

Please take the time to register your product. To register your product, follow the instructions at this link. [http://www.edgeproducts.com/product\\_registration.php](http://www.edgeproducts.com/product_registration.php)

### **Benefits of product registration:**

- **Your Safety** – registering your product allows us to know exactly which product you have and provide important product updates to you that improve the quality and/or safety of the product
- **Enhanced Features** – almost all Edge products are easily updated via the internet. We are constantly adding new features and improvements to our product that we know you will want to enjoy
- **Confirmation of Ownership** – provides a record in case of product loss, theft, or required warranty work. When you call us for support our team will already have much of the information they need to help you!
- **Improved Product Development** – helps us better understand you (our customers) and design products that meet your needs
- **Special Offers** – allows us to inform you about special offers on accessories and/or new products that fit your vehicle and enhance your driving experience

**All Edge modules and programmers are built to operate with OEM calibrations. When you take your vehicle to a service center they may, by your request or otherwise, update your vehicles calibrations. Therefore it is important that you return your vehicle to stock before taking it in for service. Edge updates its active products (i.e. those currently being manufactured) to work effectively with updated OEM calibrations. However, this process can take some time as Edge is not always made aware of calibration changes made by the OEM. In the case of discontinued products, Edge cannot ensure that your unit will work effectively if you take your vehicle to a dealership and you are given, by your request or otherwise, a new calibration.**

**Programming your vehicle may expose existing defects in your vehicle's PCM that could disable your vehicle. It is advised that you do not program your vehicle in remote locations in case of vehicle failure.**

**If you have used another tuner/programmer on your vehicle, you will need to program back to stock and remove the device before using the Edge Products Device.**

***Failure to return to stock may result in PCM failure or engine damage.***

**Note: This manual includes installation instructions to install the Juice module in various GM model years and is designed to be used with the CS/CTS Attitude monitor.**

***1. Refer to your model Year section.***

***2. Refer to the CS/CTS Attitude Manual for additional information.***

## ***About the Edge Juice***

Congratulations on purchasing the Edge *Juice* module for the GM Duramax® Diesel. If you have any questions, please contact Edge Products. We will be very happy to answer your questions about our complete product line.

The *Juice* Module is an add-on Engine Control Module (ECM) for the GM Duramax® Diesel Engine that offers additional features not available with the factory setup. Since it is an add-on ECM, it uses all the factory data, and then enhances the factory settings to optimize your truck's performance. These features may include:

- Engine temperature monitoring and power increase from the *Juice* module as engine reaches operating temperature
- Up to 6 on-the-fly selectable power settings if installing with the *CS/CTS Attitude Monitor*.
- Transmission slip monitoring – If any transmission slip is detected power is decreased to prevent the transmission from slipping.
- Smart power control during torque converter lockup to allow a smooth, easy torque converter clutch lock-up

If this is your first time driving a diesel truck with a performance module, you will notice improved fuel economy, greater performance, more power, better throttle response, passing and acceleration!

The *Juice* module regulates power delivery and timing based on engine temperature for certain models. This means that while the engine temperature is below 140° F no additional fueling or timing is delivered. At 140° F the module begins delivering fuel. The *Juice* delivers 100% of the calculated additional fuel at 160° F, and at 160° F the *Juice* also starts modifying timing.

The *Juice* module offers a large power increase over stock throughout the rpm range, but the power is most noticeable in the midrange rpm's. This greatly improves drivability and towing performance. Transmission downshifting is greatly reduced, especially while passing or towing. If you are towing, the increased power from the Edge *Juice* module will allow you to maintain speed going up a hill, keep you in a higher gear, and reduce transmission "hunting" for lower gears.

## Power Levels

Power level 1 is specifically designed to maximize fuel economy improvements. We recommend level 1 or level 2 for towing applications. Use level 2 when towing a load. Power levels are changed using the CS/CTS *Attitude* monitor.



**WARNING** *Do not exceed your vehicle's max GVWR as outlined in the vehicle's owner's manual. Doing so may result in loss of vehicle control and cause bodily injury.*

The remaining power levels are designed to match fueling with any additional upgrades you may have done to your vehicle. Level 3 is as far as you should go on a stock truck and should never be used while towing.

Level 3 is designed to take advantage of the built-in safety margins the manufacture needs to add in order to make sure your vehicle can perform at its maximum capacity. When driven responsibly, and used with an EGT gauge or the *Attitude* monitor, level 3 will not stress the stock engine or transmission as long as you are not towing.

Levels 4 and higher are performance and race levels and are designed to be used with upgraded drive trains. If you have modified your injectors, upgraded the transmission, changed turbos or performed other similar enhancements, levels 4 and higher will match fueling to the additional performance created by these upgrades.

**Caution:** *On a stock truck, the additional power may overstress the engine and transmission while driving in power levels 4 or higher, or at any level if you drive too hard. We recommend that you only use level 1 or 2 while towing to keep EGT temperatures lower and reduce transmission stress.*

## Power Level HP and Torque Gains

When power gains are noted, they are representative of an actual vehicle test. These gains were measured on a Super Flow Dyno at an altitude of 4400 ft above sea level, and represent power delivered to the rear wheels of the test truck. The only modification made to the test vehicle was the addition of the Edge Power *Juice* module. Power gains may vary somewhat on a different vehicle or in different geographic settings.



**WARNING** *Do not "stack" non-Edge recommended modules to gain more horsepower. They could be incompatible and result in powertrain failure or create dangerous conditions leading to a serious or fatal accident.*

## EGTs: What they mean and why

EGT stands for exhaust gas temperature, and is the single most important indicator of how a diesel engine is performing. Unlike a gasoline motor, a diesel motor will continue to make power as more fuel is added. As more fuel is added, heat will be generated until the motor just gets too hot and things start to melt. This is a situation you want to avoid. Exhaust gas temperature is the ideal measurement of how hot the motor is, since temperature fluctuations in exhaust gas are almost instantaneous. It is possible to generate excessive EGT on a stock truck, particularly if you are towing. This is why we always recommend installing an EGT gauge and why we build the CS/CTS *Attitude* monitor, which monitors EGT and will automatically defuel your truck when EGTs get too high.

In our experience 1350 degrees is about as high as you want to let your EGTs go. Keep in mind, the stress on your engine created by the heat is a function of both temperature and time. A brief spike to 1400 that lasts a second is not that big a deal. Pulling up a hill for several minutes at 1400 is far worse.

As you drive your vehicle in the various power settings, keep your eye on the EGTs. Depending on how you drive and where you drive, you may find a particular power level is more suitable to your power needs.

## **The Juice Module and your Transmission**

The automatic transmission has a fluid-filled clutch-like device called a torque converter. This device uses the spinning motion of the motor to drive the transmission which drives your wheels. As the truck speed stabilizes, the torque converter engages a mechanical connection which locks the two halves of the torque converter, so the output shaft is going the same speed as the input shaft. This mechanical linking of the two halves is called **Transmission Lock-up**. If the motor produces too much power, this mechanical lock-up can start to slip. When this slippage occurs, the Juice module reduces the power output to allow the transmission to function properly. This is a great feature that provides an extra level of protection for your vehicle.

## **Transmission Relearning**

The Allison transmission is a “Smart” transmission. That means that it pays attention to how smoothly the transmission is changing gears, and modifies the shifting to improve drivability. When the motor delivers more power (by adding the *Juice* module), the transmission has to ‘re-learn’ how to shift. After first installing the Juice module, you may notice rough shifting. The best way to re-teach the transmission is to set the truck in the power level you will be using most of the time. Then set out to drive, some city, some highway, varying the driving and the speed. A good rule of thumb would be 100 to 200 miles. Make sure that you shift through each gear 20 to 30 times. You will notice the shifting becoming better, and your truck responding better to the additional power as you go through the learning cycle.

## **Connecting and Installing the Juice**



**WARNING** *An electrical charge or battery acid can burn you. Battery gas can explode or ignite. Take care when working around the battery. Follow instructions in the vehicle owner’s manual for disconnecting and reconnecting a battery.*

**IMPORTANT:** *Read all Safety, Warranty, and Installation Instructions before installing this product. Read through these instructions completely so that you understand each step prior to installation.*

## Supplied Items:

1. Edge *Juice* Module
2. Harness cable set
3. Depending on your vehicle year, the accessory package will include Velcro mounting strips, wire ties and leaded fuse links.
4. EGT Thermocouple Sensor Probe

## Required Tools:

1. 21/64" (5/16" optional) Drill bit and Power Drill (for EGT installation)
2. 1/8" (NPT) National Pipe Tapered Tap and T-Handle/Wrench (for EGT installation)
3. 9/16, 5/8 and 5/16" (or 8mm wrench)
4. Phillips Screwdriver

## Mounting the Juice Module

**Notice:** Use caution when inserting connector bodies. If the connector does not slide smoothly, remove the connector, inspect the pins, and retry installation. Pull on the connectors, not the wires, when disconnecting the engine or Juice harnesses.

The Edge Power Juice Module can mount on top of or to the side of the black plastic fuse box cover located on the driver's side fender. Adhere the module using the supplied Velcro, allowing enough harness movement for removal of the box cover.

Select your year and model from the following examples to aid in installation of the harness:

### 2001-2005 GMC Duramax 6.6L LB7 & LLY

The following picture shows the Edge Power *Juice* Module with the harness cable.

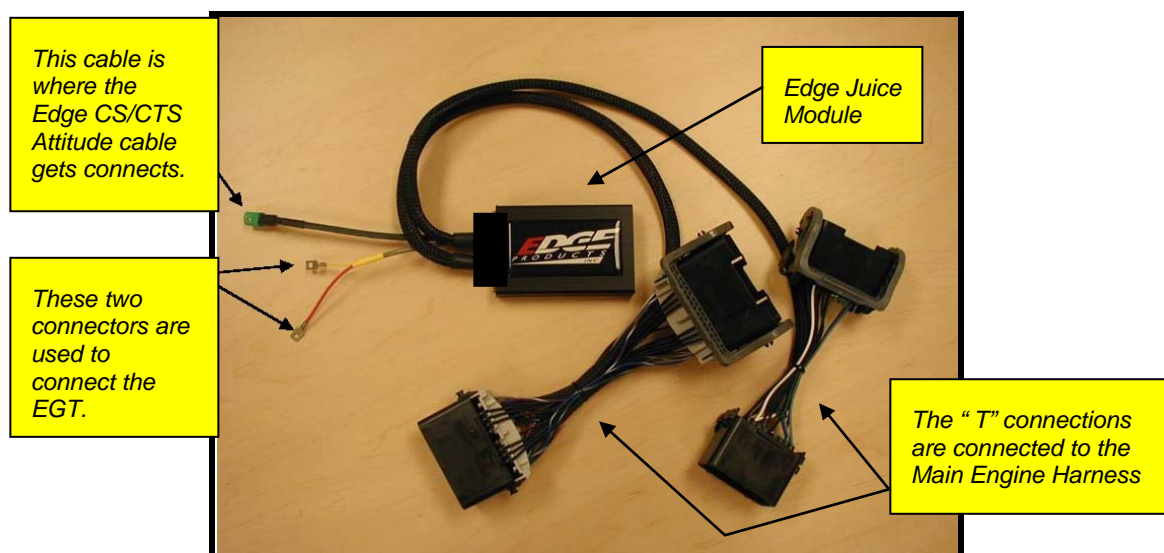

Disconnect both stock engine harness connectors by squeezing the ears on the backside of the connector and rotating the gray lever.



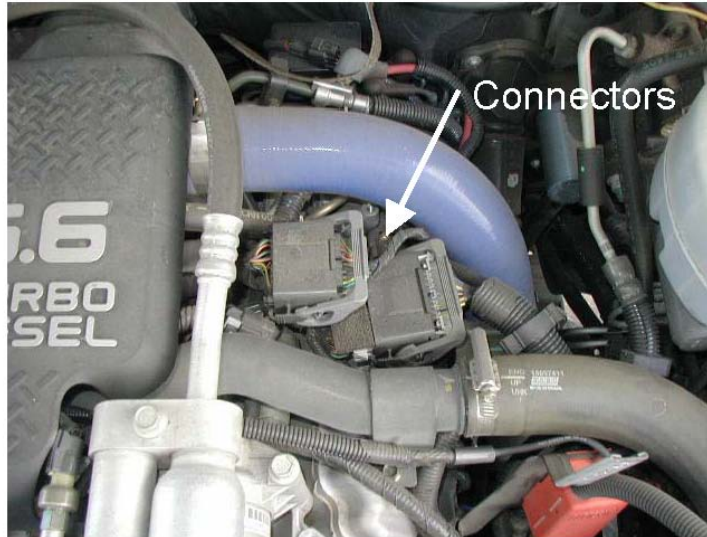

Carefully insert the *Juice* "T" harness connectors between the mating stock engine harness connectors and lock in place with the gray levers.

### **Power Gains (2001-2005 GMC Duramax LB7 & LLY)**

<b>Level</b>	<b>Horsepower</b>	<b>Torque</b>
<b>LEVEL 0</b>	<b>0</b>	<b>0</b>
<b>LEVEL 1</b>	<b>40</b>	<b>150</b>
<b>LEVEL 2</b>	<b>60</b>	<b>180</b>
<b>LEVEL 3</b>	<b>75</b>	<b>200</b>
<b>LEVEL 4</b>	<b>90</b>	<b>250</b>
<b>LEVEL 5</b>	<b>125</b>	<b>325</b>
<b>LEVEL 6 (See Hot Unlock section)</b>	<b>150</b>	<b>350</b>

**2006-2007 GMC Duramax 6.6L LLY & LBZ**

The following picture shows the Edge Power Juice Module with the harness cable. **Note:** If you have a Harness with (2) "T" connectors, the 2nd T is necessary and should be used with both "T's" installed.

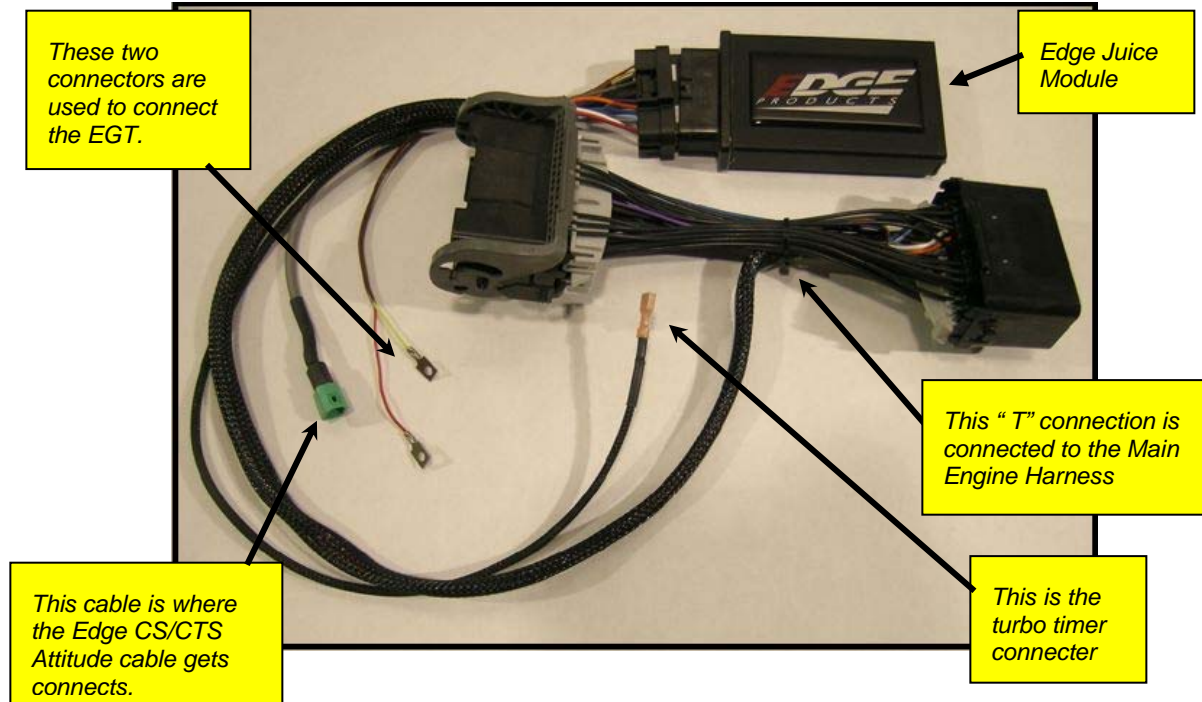

1. Disconnect stock engine connectors by squeezing the ears on the backside of the connector and rotating the gray lever.

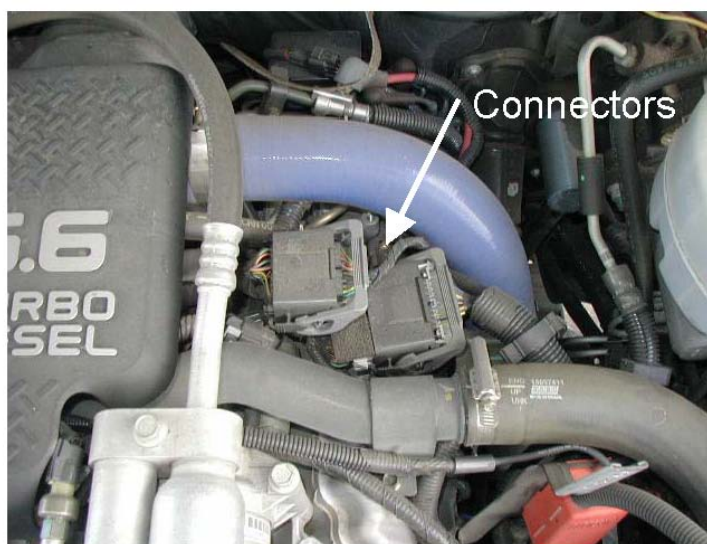

Carefully insert the Juice "T" harness connectors between the mating stock engine harness connectors and lock in place with the gray levers.

2. Route the turbo timer wire with the red female connector end into the side of the fuse box to connect the turbo timer.
3. Locate and remove the 10 amp "TBC BATT" from inside the engine compartment fuse panel.
4. Insert the Leaded Fuse Link (see figure 11). The leg with the wire soldered to it needs to plug into the "HOT" side of the fuse location. Orient the fuse exactly as shown in fuse box picture below.
5. Plug the routed turbo timer cable (routed in step 2) into the leaded fuse link connector.

**Note:** The Turbo timer will not function unless the vehicle has the Attitude CS/CTS monitor installed.

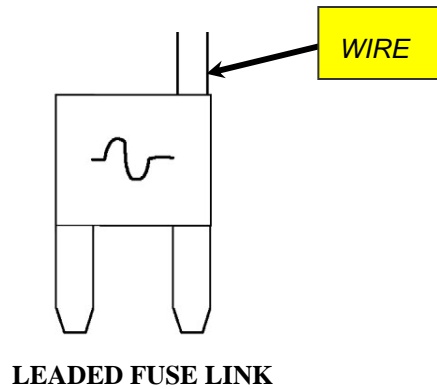

**Note:** Reference the *Diesel chart* inside the fuse box cover or operators manual for fuse identification.

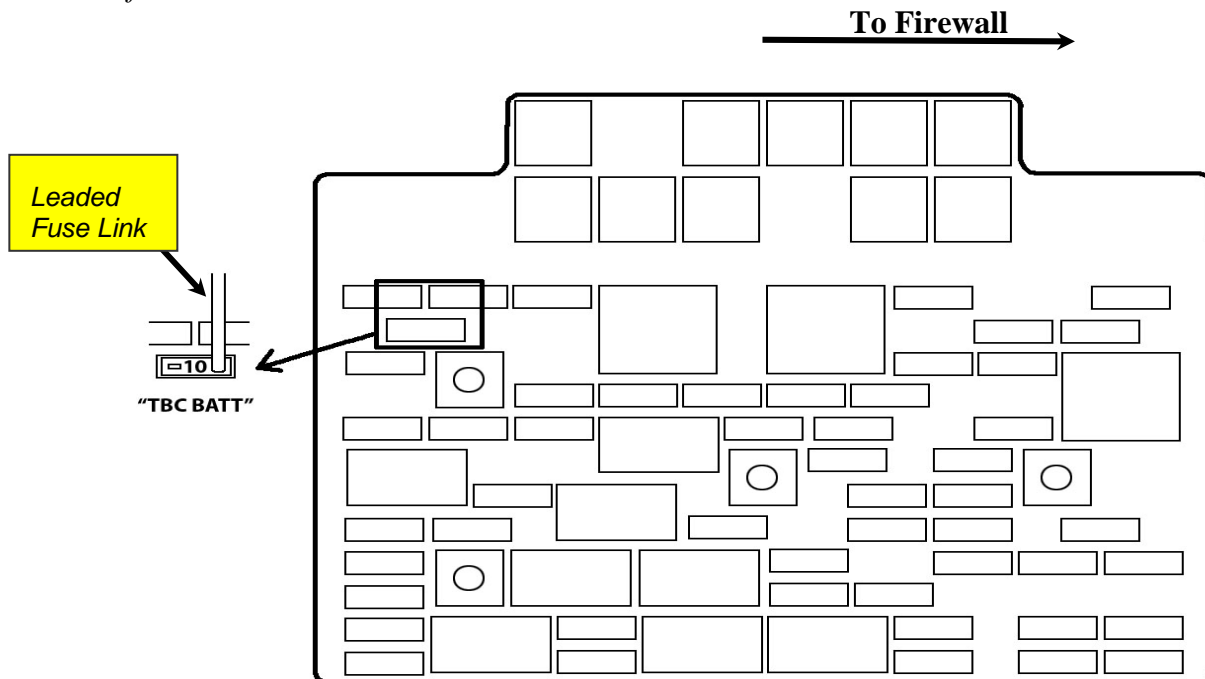

### Power Gains (2006-2007 GMC Duramax LLY & LBZ)

Level	Horsepower	Torque
LEVEL 0	0	0
LEVEL 1	30	60
LEVEL 2	40	80
LEVEL 3	50	90
LEVEL 4	60	100
LEVEL 5	80	130
LEVEL 6 (See Hot Unlock section)	100	200

### 2007.5-2010 GMC Duramax LMM

The following picture shows the Edge Power Juice Module with the harness cable.

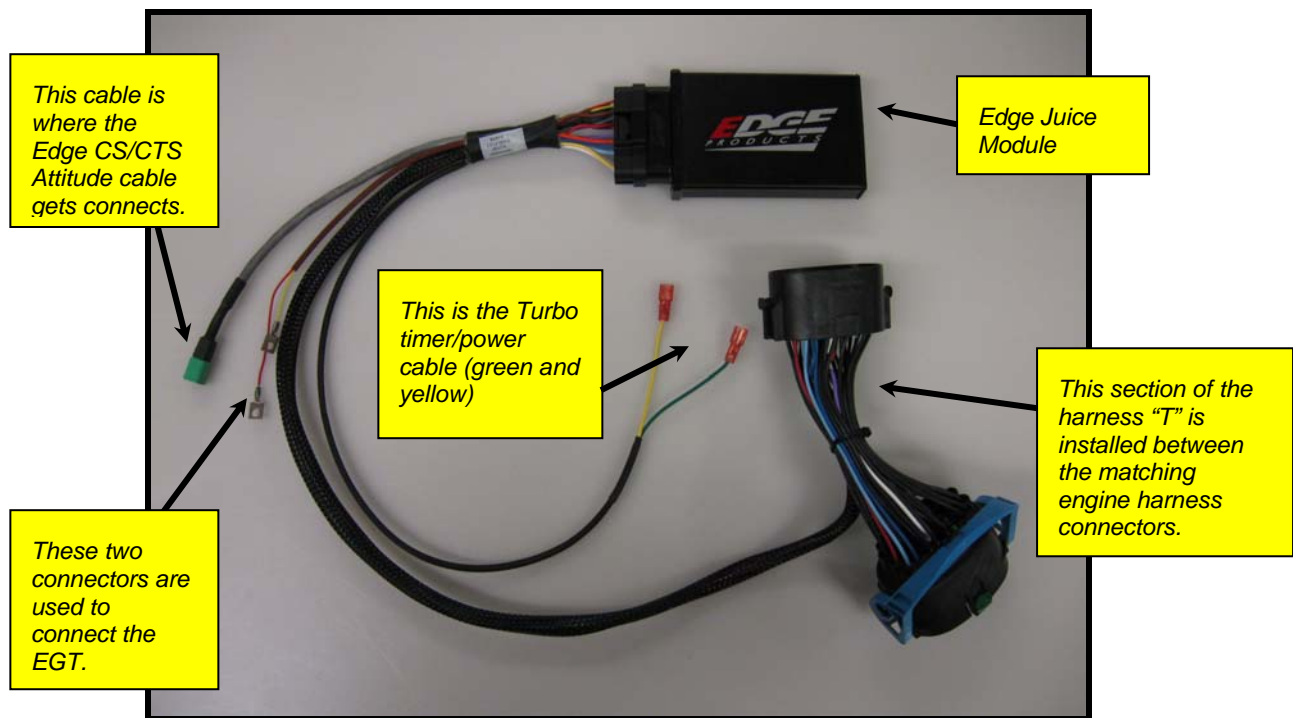

**Note: Wait 2 minutes after the key has been turned off before disconnecting the factory connection.**

1. Disconnect the black connector, by pushing back the green tab, then pressing down on the green tab firmly simultaneously rotating the blue lever back, and sliding the connector out.



Carefully insert the Juice “T” connectors and lock in place with the blue levers, and then gently connect the stock connectors to the other end of the *Juice* connectors. Lock the blue levers, by sliding the green tab back into original lock position. (see following picture for finished connection)

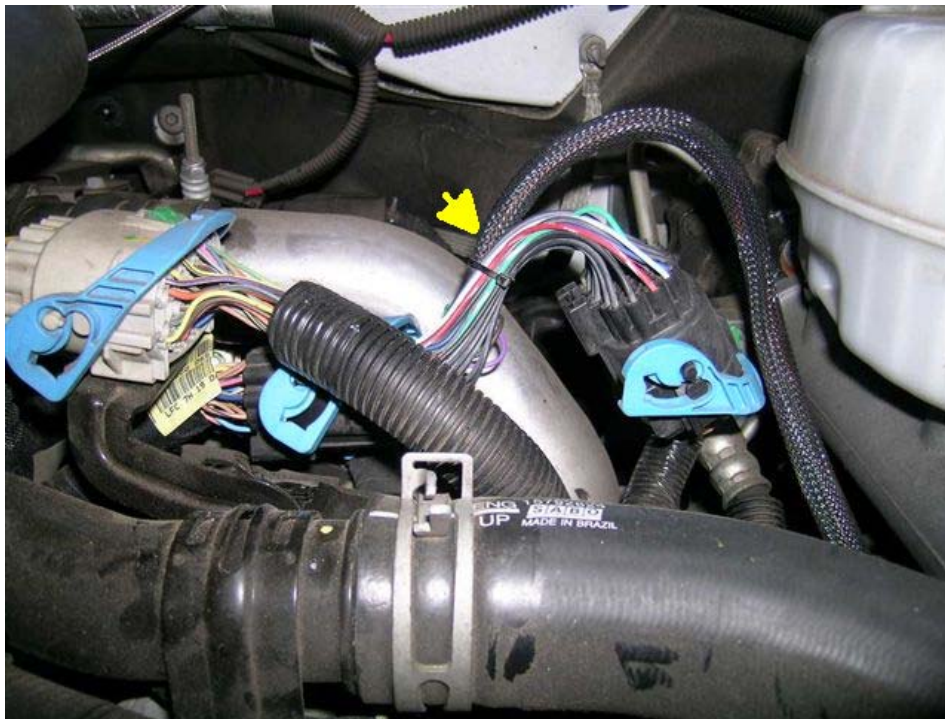

2. Route the green/yellow turbo timer wire with the red female connector end into the side of the fuse box to connect the turbo timer.
3. Locate and remove the 10 amp “IPC” (Fuse 43) and “MISC IGN” (Fuse 40) from the engine compartment fuse panel.
4. Insert the Leaded Fuse Links. The leg with the wire soldered to it needs to plug into the

*Edge Products* \_\_\_\_\_ *GM Juice-Attitude CS/CTS*  
“HOT” side of the fuse location. Orient the fuses exactly as shown in fuse box picture below.

**Note:** *The Turbo timer will not function unless the vehicle has the Attitude CS/CTS monitor installed.*

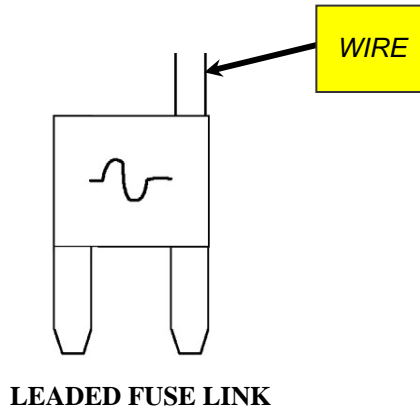

5. Connect the **green** turbo timer wire to the “IPC” (Fuse 43) fuse link. Connect the **yellow** turbo timer wire to the “MISC IGN” (Fuse 40) fuse link.

**(NOTE:** *The green wire may not be available on an older harness set and is not necessary for the 07.5-08 LMM)*

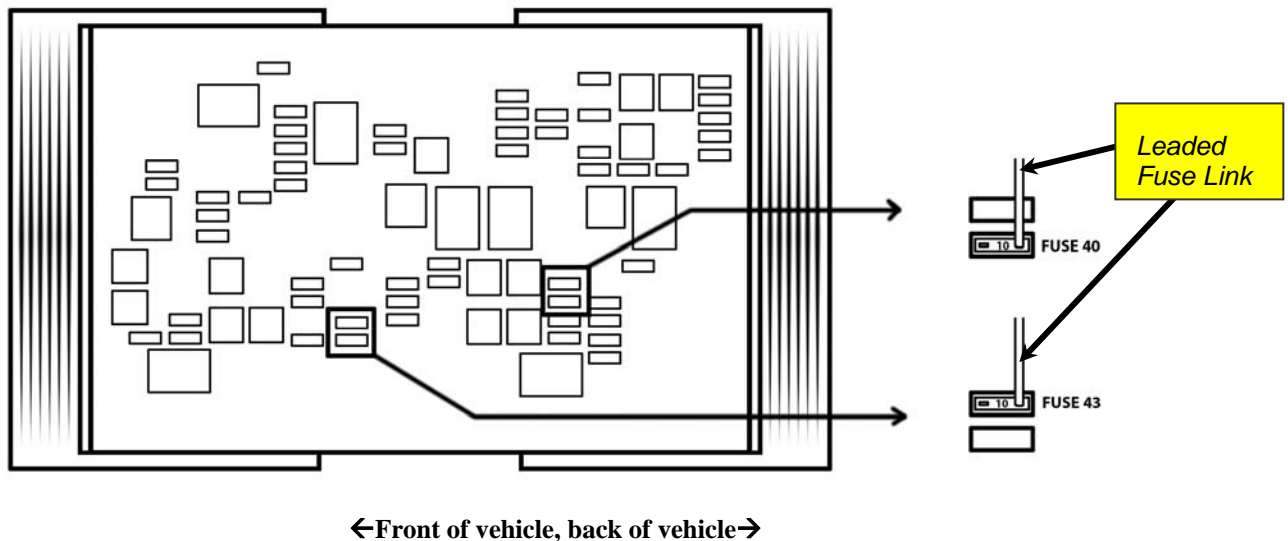

**Power Gains (2007.5-2010 GMC Duramax LMM)**

Level	Horsepower	Torque
<b>LEVEL 0</b>	<b>0</b>	<b>0</b>
<b>LEVEL 1</b>	<b>30</b>	<b>60</b>
<b>LEVEL 2</b>	<b>40</b>	<b>80</b>
<b>LEVEL 3</b>	<b>50</b>	<b>90</b>
<b>LEVEL 4</b>	<b>60</b>	<b>100</b>
<b>LEVEL 5</b>	<b>80</b>	<b>130</b>
<b>LEVEL 6 (See Hot Unlock section)</b>	<b>85</b>	<b>200</b>

**Final Inspection**

Recheck all connections for a properly secure installation. Using the supplied wire ties, secure the wiring harness to prevent possible damage.

Start the engine. The engine should start and run like a stock truck. If the engine does not start or run properly, turn off the motor, remove the keys from the ignition, **wait 2 minutes** then remove the juice module and inspect the pins inside all connectors. Straighten pins or clear foreign material from the pins and connector surfaces, then re-install the connectors. If failure conditions still exist, contact your dealer or Edge Products, LLC. When trying to restart, make sure that the key has been turned off for at least 10 seconds before cranking the engine.

***Install and Attach the EGT Probe***

It is necessary to tap a small hole into your exhaust manifold to insert the EGT sensor. The EGT probe must be mounted before the turbo for the *Juice* safety features to operate properly.



**WARNING** *When installing the EGT Thermocouple, wear eye protection and protective clothing to protect from getting metal chips in your eyes. Also, since exhaust manifolds can be very hot, allow the engine to cool before drilling. When working under the vehicle, make sure the park brake is set. If the vehicle must be raised, carefully follow the stand and vehicle safety guidelines for placement and use of jacks and stands.*

**CAUTION:** *One effective way to avoid metal fragment contamination in your engine manifold is to apply grease in the tip of the drill bit and threads of your tap tool when drilling/tapping the hole in your manifold. Reduce pressure on the drill when the drill breaks through the manifold wall to reduce risk of pushing metal chips into the manifold.*

1. Obtain a 1/8" tapered National Pipe Tap (NPT) available from your hardware store. Drill a 21/64" (5/16" optional) hole through the manifold wall, and then use the pipe tap to cut the threads. Follow the instructions provided with the tap. The pipe tap is tapered, so you will only want to turn the tap until the bottom threads of the tap are slightly deeper than flush with the inside of the exhaust manifold wall. Use caution not to tap too deep since this would cause the thermocouple fitting and probe to seat too deep. (tap deep enough to allow 3+ full threads of fitting to seat in manifold)
2. After the manifold has been drilled and tapped, remove the fitting from the Thermocouple and install by tightening the tapered thread end into the manifold with a 9/16" end wrench. (Ideally the tip of the fitting would be less than or flush with the inside of the exhaust flow path.) Tighten the fitting so that it is securely seated. Then install the probe into the fitting, and tighten the top nut of the fitting just tight enough to keep the probe firmly mounted. Make sure that the probe cable is positioned to allow best path and minimal bending, for cable routing to the top of the engine compartment.

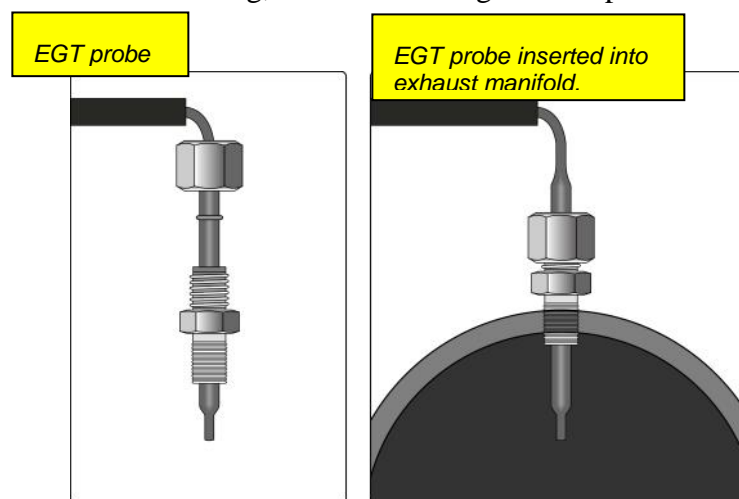

EGT PROBE INSTALLATION

**NOTE:** The probe will move approximately 90 Deg. clockwise in the direction the nut is tightened. Before fully tightening the nut, make sure the cable starts 90 Degrees from the final resting position. When tightened, the cable will be correctly positioned.

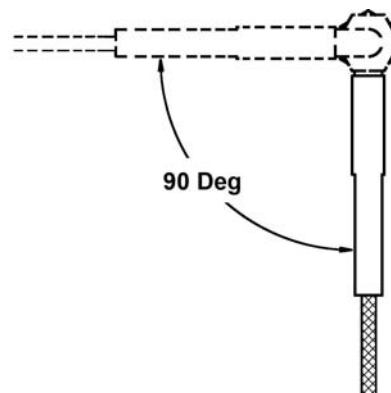

**CAUTION:** Do not bend the probe after installed. If needed, loosen the probe nut, adjust the probe, and re-tighten. Bending the probe tubing will result in a faulty probe.



Correct

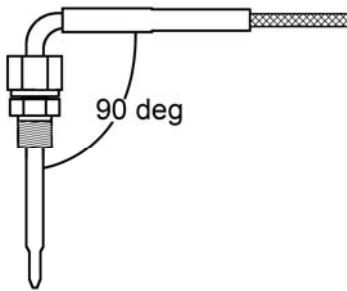

Incorrect

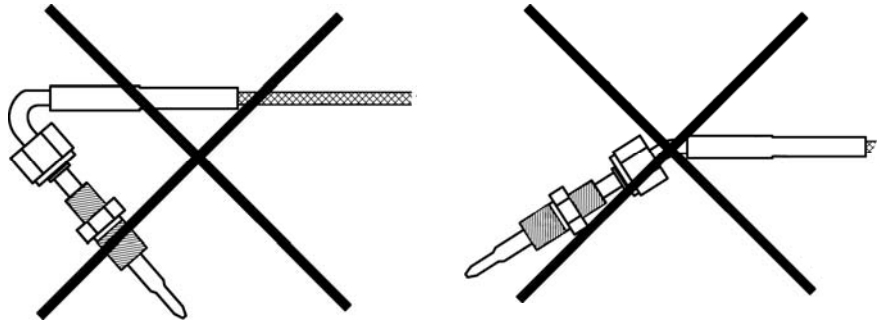

Tip: Pulling back the wheel splash guard may provide easy access to the exhaust manifold for tapping the EGT cable.

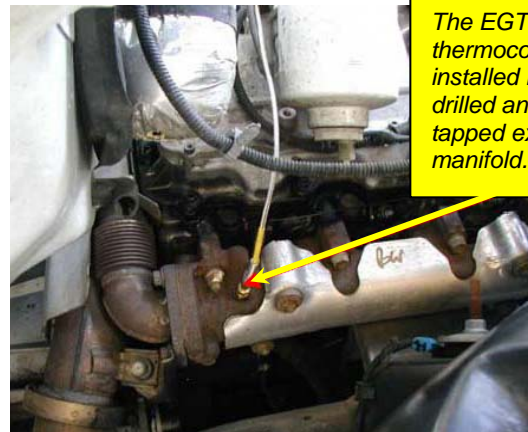

The EGT thermocouple installed into the drilled and tapped exhaust manifold.

2001-2005 GM Duramax 6.6L LB7 & LLY



The EGT thermocouple installed into the drilled and tapped hole in the exhaust manifold.

2007.5-2010 GM Duramax 6.6L LMM

3. With the Thermocouple installed and the cable routed to the top of the engine compartment, connect the (2) ring terminals to the mating *Juice* harness terminals with the supplied hardware. Position the supplied shrink wrap first and then secure the fasteners after mating to the color coded wires. Slide the heat shrink over the connections, and heat the shrink wrap to secure. Secure the excess cable to the firewall with supplied cable ties.

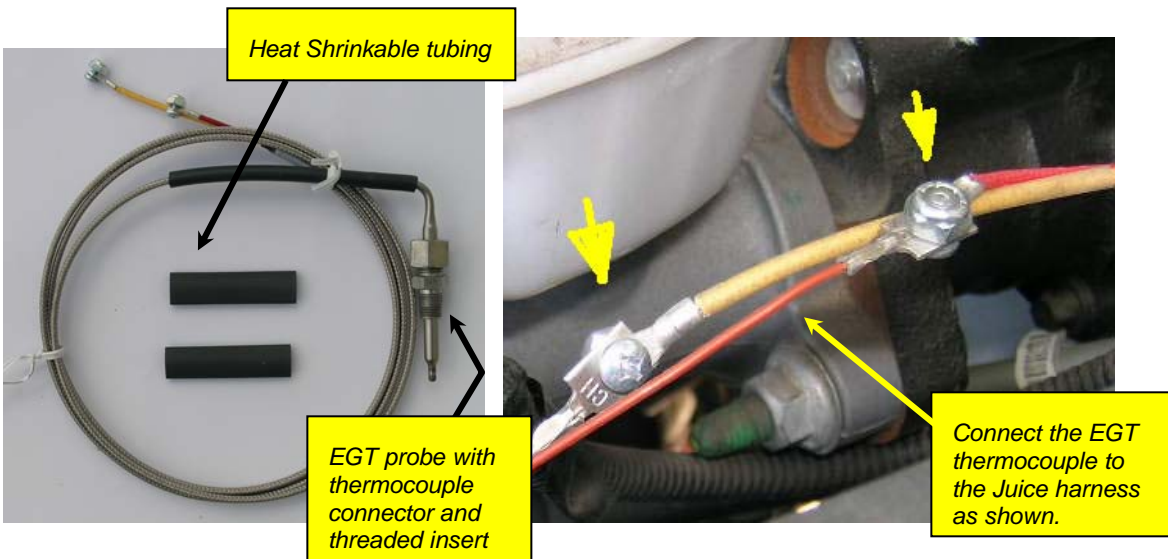

Heat Shrinkable tubing

EGT probe with thermocouple connector and threaded insert

Connect the EGT thermocouple to the Juice harness as shown.

## Attach the EAS JAB (Juice-Attitude Bridge)

The JAB is part of the EAS (Edge Expandable Accessory System). It can be used with an EAS EGT if you have one installed. The expandable Accessory system allows starting with one sensor and adding more as needed. The components connect to each other using keyed guide slots and locking nuts on each accessory. The user might start with an EGT sensor and then have flexibility to add additional sensors (including, but not limited to, a 2<sup>nd</sup> EGT sensor, JAB Attitude Bridge, Wide Band O2 sensor, Fuel Rail Pressure sensor and Turbo timer sensors, etc.).

If you have an EAS EGT installed, adding an EAS JAB (or another expandable accessory) is accomplished by removing the Terminator cap and attaching the additional accessory in its place in a daisy chain manner. Remove the Terminator Cap by turning the lock nut counter clock-wise. (The lock nut is designed to lock and requires a firm grip and force to unlock.) Attach the new accessory by aligning the guide keys in the matching connectors and turning the locking nuts to secure. Then replace the Terminator Cap on the end of the new accessory and secure the lock nut. Use a nylon tie to secure the JAB to the firewall flange along with the EAS EGT. Proceed to connect the JAB cable to the Juice harness.

1. Use the following instructions to install and attach the EAS JAB to your vehicle.

**Note:** Connect the Expandable JAB sensor, Terminator cap and EAS cable to each other by aligning the guide keys in the matching connectors and turning the lock nut until a snap is felt in the lock nuts. Hang the Expandable connector assembly as shown, using the supplied nylon ties.

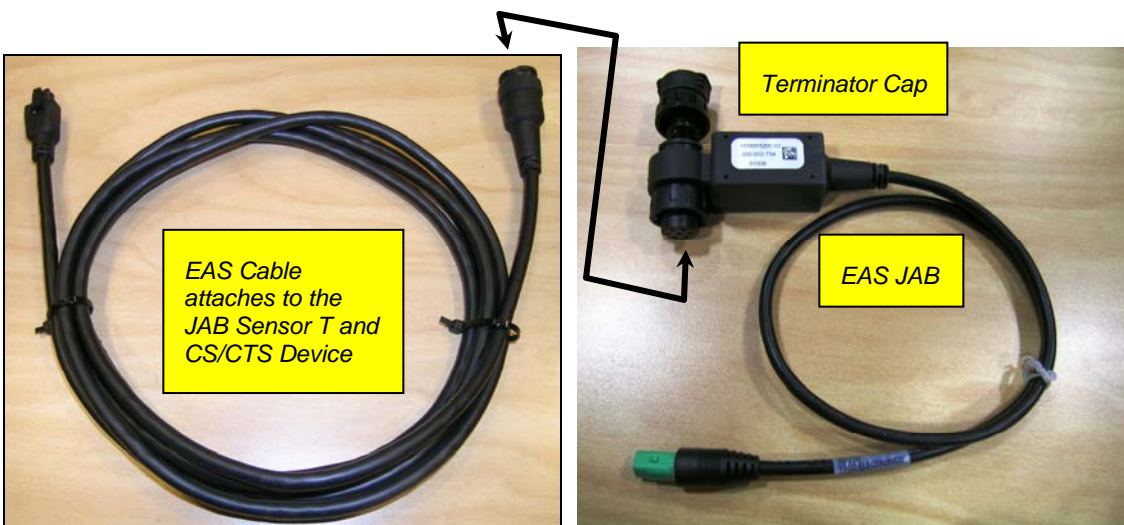

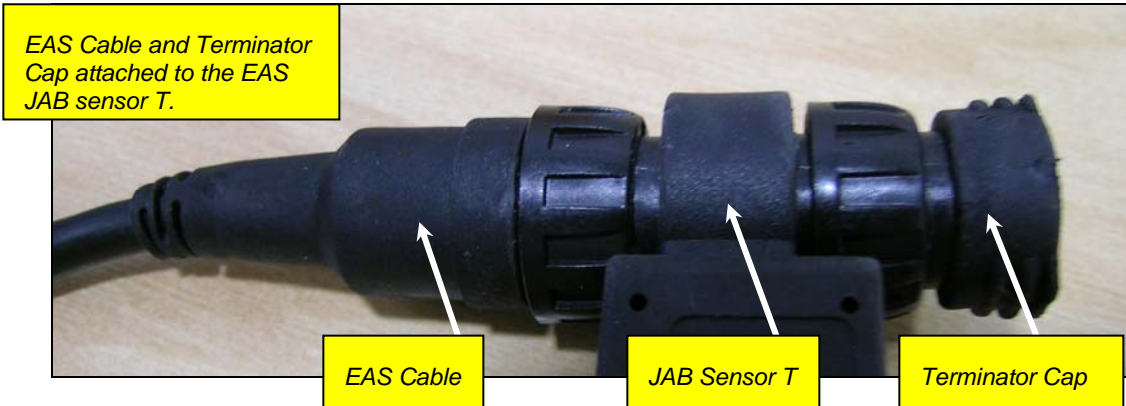

2. Hang the EAS JAB connector assembly as shown, using the supplied Nylon ties.

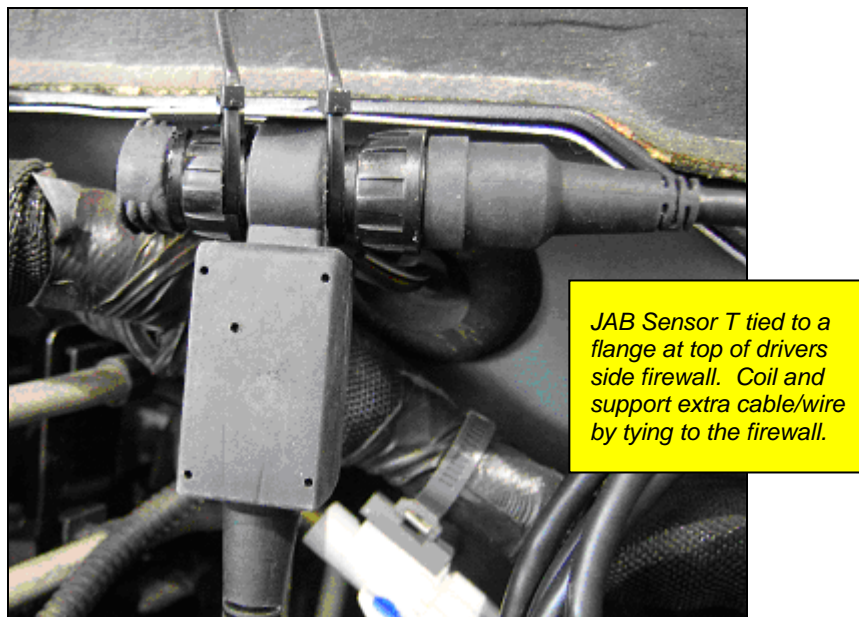

3. Connect the CS/CTS EAS JAB cable connector to the Edge Juice module harness connector by snapping the green connectors together as shown. Secure any excess cable to prevent entanglement with moving components under the hood.

**Edge Products**

**GM Juice-Attitude CS/CTS**

**Note:** If the Juice module had previously been installed with the 3- position power level switch or another Edge device, the switch cable will have to be disconnected or removed to allow the CS/CTS Attitude cable to be installed. Carefully lift the latch on the Juice connector side to allow the connector to release.

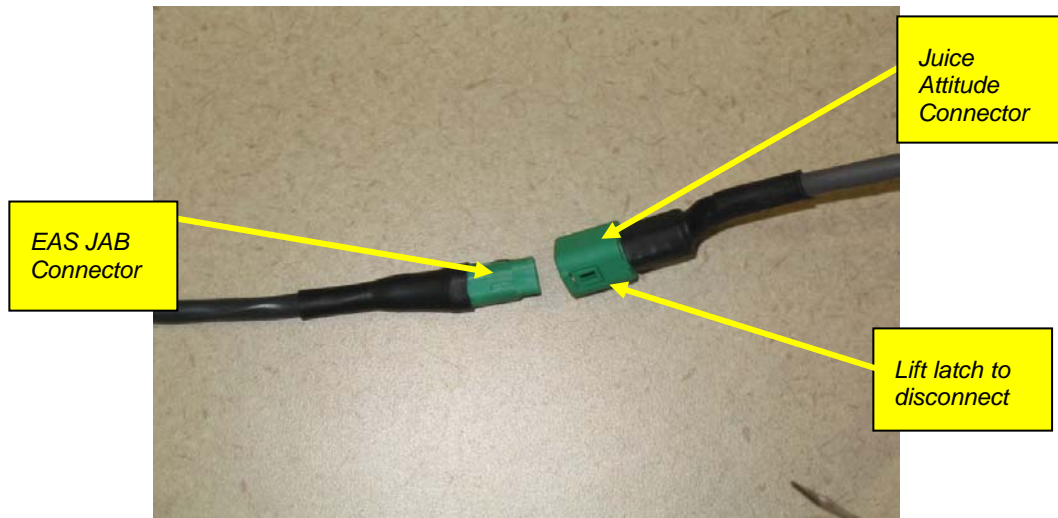

4. Route the EAS cable through the main grommet or other suitable hole in the firewall, and into the cab of the vehicle (under the dashboard). Secure any excess cable to the firewall with supplied nylon ties.

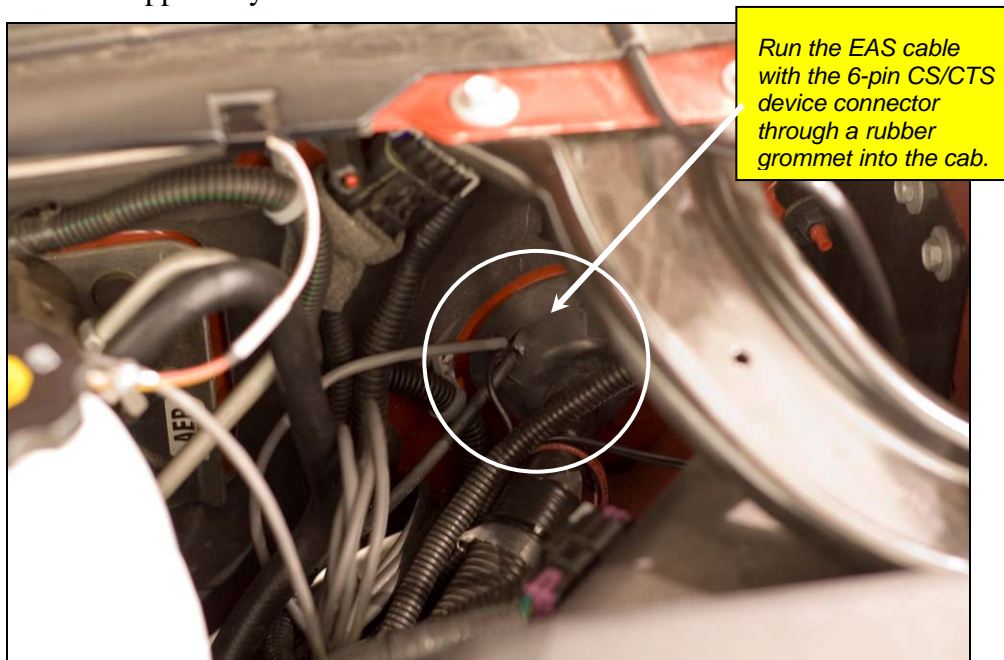

5. Run the cable up under the dash. Open the driver's side door, and remove the access panel on the left side of the dashboard. (The panel will typically unsnap when the bottom is pulled out.) Remove fasteners if required, and route the cable behind the panel and up to the A-pillar. Replace the screws, and access panel. The cable will protrude from the dashboard up along the A-pillar and be able to move freely when pulled.



**WARNING** *Secure excess cable under the dash with supplied nylon ties. Ensure excess cable does not interfere with pedal or other mechanical linkage during operation of the vehicle.*



*Route cable along and under the door seal, and around the bottom of the A-Pillar*

6. With roughly 8 to 10 inches of the EGT cable extending above the dashboard, plug the 6-pin connector into the accessory port on the back of the CS/CTS device.

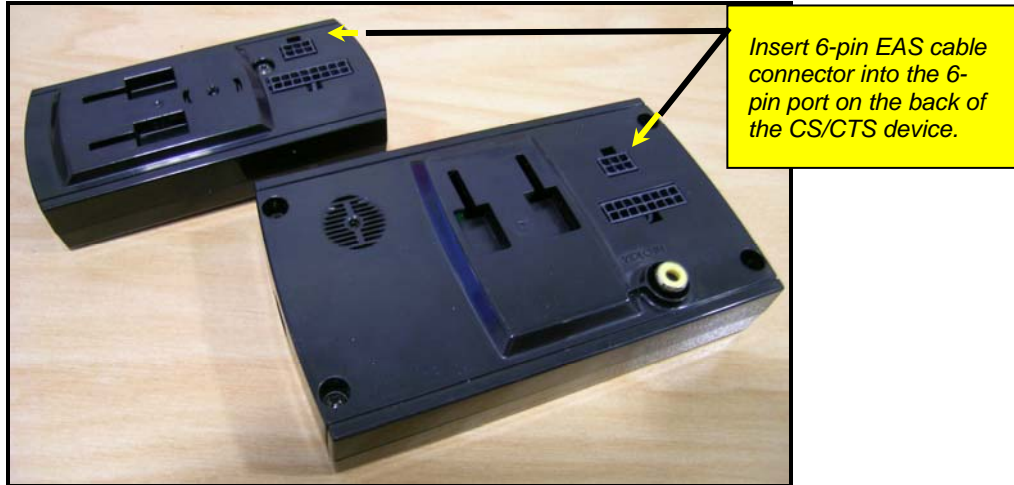

7. With the cable connected turn the ignition key ON and touch the screen. Verify readings display on the CS/CTS Device.



## Hot Unlock Code

The Juice module is equipped with an optional level 6. This level is a high performance level, and should be used only when proper power and drive-train upgrades have been made.

After installing the device the following Race Unlock code screen will display. Record the Serial Number and have it available when you go to the website link. The Serial Number of your product is found at the top of the screen.



To unlock level 6 (HOT) you will need to visit [www.edgeproducts.com](http://www.edgeproducts.com) and download the Hot Unlock Form waiver. You will find this form in the sub-menu Hot Unlock Form, located on the home page of the website, or the form can be found by following the link:

[http://www.edgeproducts.com/product\\_images/customer\\_support\\_article-pdf-32.pdf](http://www.edgeproducts.com/product_images/customer_support_article-pdf-32.pdf)

Once you completely fill out the form, you will fax it to the number listed on the Hot Unlock Form. The Hot Unlock option costs \$100.00.

After completing the information, the code will immediately be emailed to the email address you have entered, and you will have electronically signed and accepted responsibility for the use of this product.

Be sure to record the Serial Number along with the unlock code when you receive it. You will need this code at a later step to finish the installation instructions or when you upgrade your product.

Serial Number		Unlock Code	
---------------	--	-------------	--

After receiving the Hot Unlock Code, enter the code using the *Enter the Hot Unlock code* on the *Setup* Screen to activate the Power Level 6.



1. For the CS, enter the Unlock Code by using the buttons. Press the Up or Down Arrow and [ENTER] alternately until the last digit of code is entered. Then press [ENTER]
2. For the CTS, enter the Unlock Code by using the alpha-numeric touch pad on the screen. Enter the code in sequence until the last digit is entered.



3. After the last digit of the code is entered, the following screen will appear. Refer to the Owner's Manual and read disclaimer and terms/conditions of use. After reading the disclaimer and terms/conditions of use, press [ENTER] for the CS or touch YES for the CTS to accept.



4. When complete, the monitor will indicate that "Level 6 has been UNLOCKED". Press [ENTER] for the CS or touch the screen for the CTS to return to the Main Menu. After returning to the Main Display screen, press the up arrow until you reach level 6.



## Warranty Information

### LIMITED 1 YEAR WARRANTY

Edge Products, LLC, (hereafter "**SELLER**") gives Limited Warranty as to description, quality, merchantability, fitness for any product's purpose, productiveness, or any other matter of **SELLER's** product sold herewith. The **SELLER** shall be in no way responsible for the product's open use and service and the **BUYER** hereby waives all rights other than those expressly written herein. This Warranty shall not be extended or varied except by a written instrument signed by **SELLER** and **BUYER**.

The Warranty is Limited to one (1) year from the date of sale and limited solely to the parts contained within the product's kit. All products that are in question of Warranty must be returned shipping prepaid to the **SELLER** and must be accompanied by a dated proof of purchase receipt. All Warranty claims are subject to approval by Edge Products Inc.

Under no circumstances shall the **SELLER** be liable for any labor charged or travel time incurred in diagnosis for defects, removal, or reinstallation of this product, or any other contingent expenses.

If the **BUYER** sends back a failed unit that is out of warranty and chooses to buy a refurbished unit, the refurbished unit will only carry a 90 day warranty. If the **BUYER** purchases a new unit at a predetermined discounted rate, it will have the standard 1 year warranty.

Under no circumstances will the **SELLER** be liable for any damage or expenses insured by reason of the use or sale of any such equipment.

THE INSTALLATION OF THIS PRODUCT INDICATES THAT THE **BUYER** HAS READ AND UNDERSTANDS THIS AGREEMENT AND ACCEPTS ITS TERMS AND CONDITIONS.

IN THE EVENT THAT THE BUYER DOES NOT AGREE WITH THIS AGREEMENT, THE BUYER MAY PROMPTLY RETURN THIS PRODUCT, IN A NEW AND UNUSED CONDITION, WITH A DATED PROOF OF PURCHASE, TO THE PLACE OF PURCHASE WITHIN THIRTY (30) DAYS FROM DATE OF PURCHASE FOR A FULL REFUND.

### IMPORTANT INFORMATION ABOUT YOUR VEHICLE'S WARRANTY

Many of our customers ask, "Will your product void my vehicle's manufacturer's warranty?" While the answer is straightforward from a legal standpoint, it's important to educate our customers (and all aftermarket consumers) on some industry realities and offer some common sense precautions to minimize your risk. Edge is committed to providing quality products that are safe to use. Our products do not cause damage to a vehicle when used as intended. *Please keep in mind that towing in anything higher than the towing level and hard driving in race or extreme performance levels is not recommended.*

Consumers of aftermarket products are protected by the Federal Magnusson-Moss Warranty Act. The Act states that if something breaks on your vehicle and you take it in for warranty repair, the dealer must honor your warranty unless whatever modifications you have added to your vehicle actually caused the problem in question.

However, the reality is that many dealerships have been known to void warranties on vehicles that use aftermarket products as a matter of policy. This applies in particular to those aftermarket products that produce horsepower, such as performance enhancement "chips," modified intake manifolds, or aftermarket exhaust systems, regardless of product brand.

You have strong legal protection as a consumer in regard to your vehicle's warranty. However, Edge strongly recommends you always disconnect and remove your module/programmer and monitor when you take your vehicle to a dealer for warranty work. In addition, leaving the product connected may affect dealer diagnostic analysis and CAN tool functions. Edge makes every effort to produce

**Edge Products** \_\_\_\_\_ **GM Juice-Attitude CS/CTS**  
product that can be easily removed. **NOTE:** *Even if you disconnect your unit, your dealer can detect the use of any programmer—even if the unit has been removed.*

Thank you for purchasing the Edge *Juice* Module and *Attitude* Monitor for the Dodge Cummins® Diesel. The *Juice* and *Attitude* have been developed and produced from the highest quality materials available to ensure the best performance for years to come. If you have any concerns or questions, please contact us.

**NOTE:** *This warranty is void for any new products purchased through auction websites. Warranty is valid only for new products purchased through Authorized Dealers (proof of purchase required for all warranty claims).*

## Glossary of Terms

**Backdown** – This is decreasing the amount of additional fueling. % Backdown is the percentage of **additional** fuel held back. The *Juice/Attitude* includes a feature to backdown the fueling to control critical parameters such as EGT and Boost.

**Barometric pressure** – This is a measurement of the atmospheric pressure, mainly due to your altitude (above or below sea level) and the current weather conditions.

**Boost** – This is how much additional air pressure is added to the intake/throttle body of the truck by the Turbocharger.

**Defueling** – This is decreasing the amount of fuel added to the motor (see Backdown). Both the PCM and the *Juice* do defueling, but the *Juice* can only ‘Backdown’ to stock fuel. The *Juice* does not ‘Backdown’ below stock fueling.

**CS/CTS** – Color Screen/ Color Touch Screen. Full-color digital display device using the *Evolution* platform.

**DPF- Diesel Particulate Filter.** Filters Soot generated during the fuel combustion cycle.

**EAS JAB** --Edge Expandable Accessory System Juice-Attitude Bridge. Connects the Juice to the CS/CTS Attitude monitor.

**ECM - Engine Control Module**

**EGT** – Exhaust Gas Temperature. This is the temperature of the hot burned gases leaving the engine through the exhaust. Generally, EGT should not be permitted beyond 1450°F to prevent turbocharger damage.

**GVWR - Gross Vehicle Weight Rating.** The maximum allowable weight of the fully loaded vehicle, including liquids, passengers, cargo and the tongue weight of any towed vehicle.

**Low Boost Fueling** – This is a *Juice* setting controlling extra fueling before the turbo boost builds. The higher the setting, the more fuel the *Juice* adds

**PCM** – Powertrain Control Module. This is the main onboard computer that controls the operation of the engine and transmission.

**Power braking** – This is the process of revving the engine while keeping the brakes on. This is done to spool the turbo to a usable level (for racing).

**Spooling** – This is the process of generating turbo boost pressure by revving the motor.

**Thermocouple** – This is a device used for measuring the temperature of the exhaust gases.

**Turbo/Turbocharger** – This device takes advantage of the hot exhaust gases to pump extra air into the engine intake.

### Technical Support:

**888-360-3343**

To expedite your support call, please have your Vehicle Information, Part Number, Serial Number, and Date of Manufacture ready prior to calling Technical Support. The *Edge Products* information is found on the label located on the bottom of the device.